



# Integra<sup>®</sup> MicroFrance<sup>®</sup>

## Catalogue Integra ORL - Oreille

<b>Table des matières</b>	<b>ii</b>	<b>Ciseaux Metzenbaum petits, finition mat</b>	<b>28</b>	<b>Micro pince guillotine</b>	<b>46</b>
<b>Service Client et Garanties</b>	<b>iv</b>	<b>Ciseaux de Mayo, finition mat</b>	<b>29</b>	<b>Micro pince à piston</b>	<b>47</b>
<b>Indications / Contre-indications</b>	<b>v</b>	<b>Pince à disséquer fine</b>	<b>30</b>	<b>Micro bistouri</b>	<b>48</b>
<b>Consultation</b>	<b>2 - 4</b>	<b>Pince à disséquer Adson</b>	<b>31</b>	Micro bistouri aspirateur à soupape	48
Micro crochet	2	striés	31	Micro bistouri falciforme	48
Porte-coton	2	à griffes	31	Micro bistouri longitudinal	48
Sonde stylet	2	<b>Pince à disséquer moyenne</b>	<b>32</b>	Micro ciseau burin	48
Anse	3	<b>Pince à disséquer bipolaire moyenne</b>	<b>33</b>	Micro Instrument double	48
Haricot	4	Câbles bipolaires	33	<b>Micro miroir - Micro rugine - Micro décolleur</b>	<b>49</b>
<b>Myringoplastie</b>	<b>5 - 6</b>	Pince mors à griffes	33	<b>Curette droite - Micro curette</b>	<b>50</b>
<b>Bistouri - Scalpel</b>	<b>7</b>	Pince mors lisses	33	Curette droite de Volkman 170mm	50
<b>Spéculum</b>	<b>8 - 9</b>	Pince mors striés	33	Micro curette angulée 160mm	50
Spéculum de consultation	8	<b>Pince à disséquer monopolaire moyenne</b>	<b>34</b>	Micro curette double angulée 155mm	50
Spéculum de consultation	9	Câbles monopolaires	34	Micro curette double droite 170mm	50
Spéculum à manche	9	Pince Adson	34	Micro curette droite 170mm	50
<b>Bras articulé</b>	<b>10</b>	Pince mors à griffes	34	Micro curette fenêtrée 165mm	50
<b>Pince à disséquer coudée</b>	<b>11</b>	Pince mors lisses	34	<b>Micro palpateur - Micro pointe</b>	<b>51</b>
Pince mors à griffes	11	Pince mors striés	34	<b>Micro crochet</b>	<b>52</b>
Pince mors curettes	11	<b>Porte-aiguille mors tungstène</b>	<b>35</b>	<b>Autres micro instruments</b>	<b>53</b>
Pince mors striés	11	<b>Pince hémostatique fine</b>	<b>36</b>	Désépithélisateur	53
<b>Seringue</b>	<b>12</b>	<b>Pince hémostatique moyenne</b>	<b>37</b>	Micro crochet manche cuillère	53
Corps de seringue	12	<b>Pince hémostatique striée</b>	<b>38</b>	Micro crochet - Micro rugine	53
Joint pour seringue	12	<b>Pince à griffes fortes</b>	<b>39</b>	Micro désarticulateur	53
Seringue	12	<b>Aspirateur à soupape</b>	<b>40</b>	<b>Micro coagulation</b>	<b>54</b>
<b>Décolleur - Rugine</b>	<b>13</b>	Jankowski	40	Câbles bipolaires	54
<b>Rugine courbe</b>	<b>14</b>	Lempert	40	Câbles monopolaires	54
<b>Ecarteur</b>	<b>15 - 16</b>	Micro aspirateur irrigateur à soupape	40	Décolleur courbe monopolaire	54
<b>Ecarteur autostatique courbe</b>	<b>17</b>	Wertheimer	40	Pince bipolaire	54
<b>Ecarteur autostatique</b>	<b>18</b>	<b>Raccord - Micro aspirateur</b>	<b>41</b>	Pointe monopolaire courbe mousse	54
<b>Ecarteur autostatique grand modèle</b>	<b>19</b>	<b>Micro aspirateur à soupape</b>	<b>42</b>	<b>Micro mensurateur</b>	<b>55</b>
<b>Ecarteur autostatique articulé</b>	<b>20</b>	<b>Micro aspirateur Luer-lock</b>	<b>43</b>	<b>Pose de prothèse</b>	<b>56 - 58</b>
<b>Maillet</b>	<b>21 - 22</b>	Aspirateur coudé	43	Micro fourche	56
<b>Ciseau burin</b>	<b>23</b>	Aspirateur malléable	43	Micro mensurateur à ossiculoplastie	56
<b>Rongeur</b>	<b>24</b>	Micro aspirateur rétreint à crépine	43	Modeleur de Schucknecht	56
<b>Pince gouge double articulation</b>	<b>25</b>	<b>Micro pince mors striés</b>	<b>44</b>	Micro punch pour silastic	56
<b>Ciseaux pointus courts, finition mat</b>	<b>26</b>	Pince mors alligator	44	Gabarit découpeur à cartilage	57
<b>Ciseaux mousses courts, finition mat</b>	<b>27</b>	Pince mors striés	44	Lame de remplacement pour gabarit découpeur	57
		<b>Micro ciseaux - Micro pince curette</b>	<b>45</b>	Presse-greffe écreuseur	57
				Micro perforateur	58
				Gabarit à piston	58
				Plaque lisse	58
				<b>Otoplastie - Pédale d'aspiration</b>	<b>59</b>
				<b>Set de Cause</b>	<b>60 - 61</b>
				<b>Instruments de Marquet</b>	<b>62</b>

<b>Instruments de Austin</b>	<b>63</b>	<b>Cupule, Plateau</b>	<b>76</b>
<b>Instruments de Guilford-Wright, de Shea</b>	<b>64</b>	Cupules	76
<b>Instruments de Hough</b>	<b>65</b>	Plateau inox	76
<b>Instruments de Jordan</b>	<b>66</b>	<b>Panier et support inox</b>	<b>77</b>
<b>Set Otoscopique de Thomassin</b>	<b>67 - 68</b>	<b>Autres paniers et supports</b>	<b>78</b>
Micro décolleur double	67	<b>Index numérique</b>	<b>81</b>
Micro rugine- Micro crochet	67	<b>Tableau d'équivalence à titre informatif</b>	<b>85</b>
Aspirateur coudé	68		
Container	68		
Manche aspirateur à soupape	68		
Micro pince mors curettes	68		
Micro pince mors striés	68		
Support	68		
<b>Set Otoscopique de l'oreille</b>	<b>69 - 70</b>		
Bistouri lancéolé	69		
Container	69		
Curette double	69		
Support	69		
Décolleur aspirateur	69		
Aspirateur à soupape	70		
Micro pince à serrer le piston métallique	70		
Micro pince mors alligator	70		
Presse-greffe écraseur	70		
<b>Otoneurochirurgie</b>	<b>71 - 73</b>		
Micro aspirateur à soupape	71		
Micro aspirateur irrigateur	71		
Micro aspirateur raccord luer-lock	71		
Ecarteur autostatique	72		
Micro ciseaux	72		
Micro pince	72		
Bistouri	73		
Crochet	73		
Curette	73		
Décolleur	73		
Dissecteur boule	73		
Pince mors curettes	73		
Pointe	73		
Rugine	73		
<b>Set de Selesnick</b>	<b>74 - 75</b>		
Bistouri	74		
Ciseaux	74		
Crochet	74		
Curette	74		
Décolleur	74		
Pince mors curettes	74		
Ecarteur autostatique courbe	75		
Pince bipolaire	75		

## Garantie limitée d'Integra

Pour connaître les garanties applicables, merci de vous référer aux garanties précisées dans l'emballage de chaque produit.

## Contacts Services Clients :

### International

+33 (0) 4 37 47 59 50  
+33 (0) 4 37 47 59 25 (fax)  
csemea@integralife.com

### France

+33 (0) 4 37 47 59 10  
+33 (0) 4 37 47 59 29 (Fax)  
custservfrance@integralife.com

### Belgique & Luxembourg

+32 (0) 2 257 4130  
+32 (0) 2 253 2466 (Fax)  
custsvcbenlux@integralife.com

### Royaume-Uni

+44 (0) 1264 312 725  
+44 (0) 1264 312 821 (Fax)  
custsvcs.uk@integralife.com

### Pays-Bas

+31 (0) 852 083 167  
+31 (0) 207 093 627 (Fax)  
custsvcnetherlands@integralife.com

### Italie

+39 (0) 2 577 8921  
+39 (0) 2 575 113 71 (Fax)  
custsvitaly@integralife.com

## Instrumentation O.R.L. MicroFrance®

### INDICATIONS

- Tous les dispositifs médicaux présentés dans ce catalogue sont indiqués pour les consultations ORL et/ou la chirurgie ORL.
- Les dimensions présentes dans ce document ne sont pas contractuelles et sont données à titre indicatif seulement.

### CONTRE-INDICATIONS

- Ne pas utiliser dans d'autres indications que celles prévues (mentionnées) dans la notice d'instructions ou l'étiquetage.

### Explications sur la présentation de ce catalogue

Titre et/ou famille produit

Consultation

INTEGRA  
LIMIT UNCERTAINTY

Marquet      Legent

Représentation de l'instrument à l'échelle 1/1 sauf indications contraires

Tableau explicatif voir ci-dessous

Vue détaillée de l'instrument

Micro crochets mousses 90°			Micro crochet mousse 45°		Porte-coton bout torsillé	Sonde stylet caudé à plaque protège-caudique
MCO805	MCO805A	MCO806	MCO807		7719-2	7731
16mm	16mm	16mm	16mm	140mm	120mm	110mm
2mm	2,5mm	0,8mm	1mm	Ø 1,2mm		longueur utile 80mm

DOCUMENT DESTINE A L'EUROPE, AU MOYEN-ORIENT ET A L'AFRIQUE.

3

### Explications sur le tableau référence produit et description complémentaire

Titre ou sous titre	
description complémentaire globale	
Réf. produit1	description complémentaire1
Réf. produit2	description complémentaire2

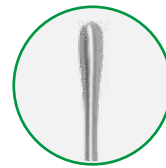
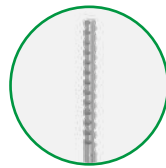
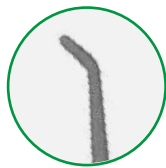

**Marquet**

**Legent**



Micro crochets mousses  
90°

Micro crochet mousse  
45°

Porte-coton bout tortillé  
15mm

Sonde stylet coudé  
à plaque porte-caustique

165mm

165mm

140mm

110mm

**MCO805** **MCO805A** **MCO950**

**MCO807**

**7719-2**

**7731**

2mm 2,5mm 0,8mm

1mm

Ø 1,2mm

longueur utile 80mm

**Billeau**

**Snellen**

**Trautmann**

**Saint-Paul**



Anse mousse ovale

160mm	140mm	200mm	170mm	90mm
7718	7885	7885A	7888	7886
4mm	4,5mm	4mm	4mm	2,5mm



Photo à titre indicatif, sans échelle

Haricot inox

7875<sup>(D)\*</sup>

<sup>(D)</sup> Distribué par Integra MicroFrance SAS (France) - Voir tableau d'équivalence annexe pour la référence du fabricant correspondante.

\* Veuillez vérifier auprès de votre représentant commercial la disponibilité de ce produit dans votre pays.



"LU" Longueur utile

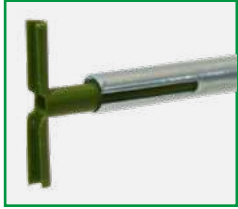

Micro inserteur à poser le drain T-tube<sup>®</sup> silicone 12mm

MCO781

LU 95mm

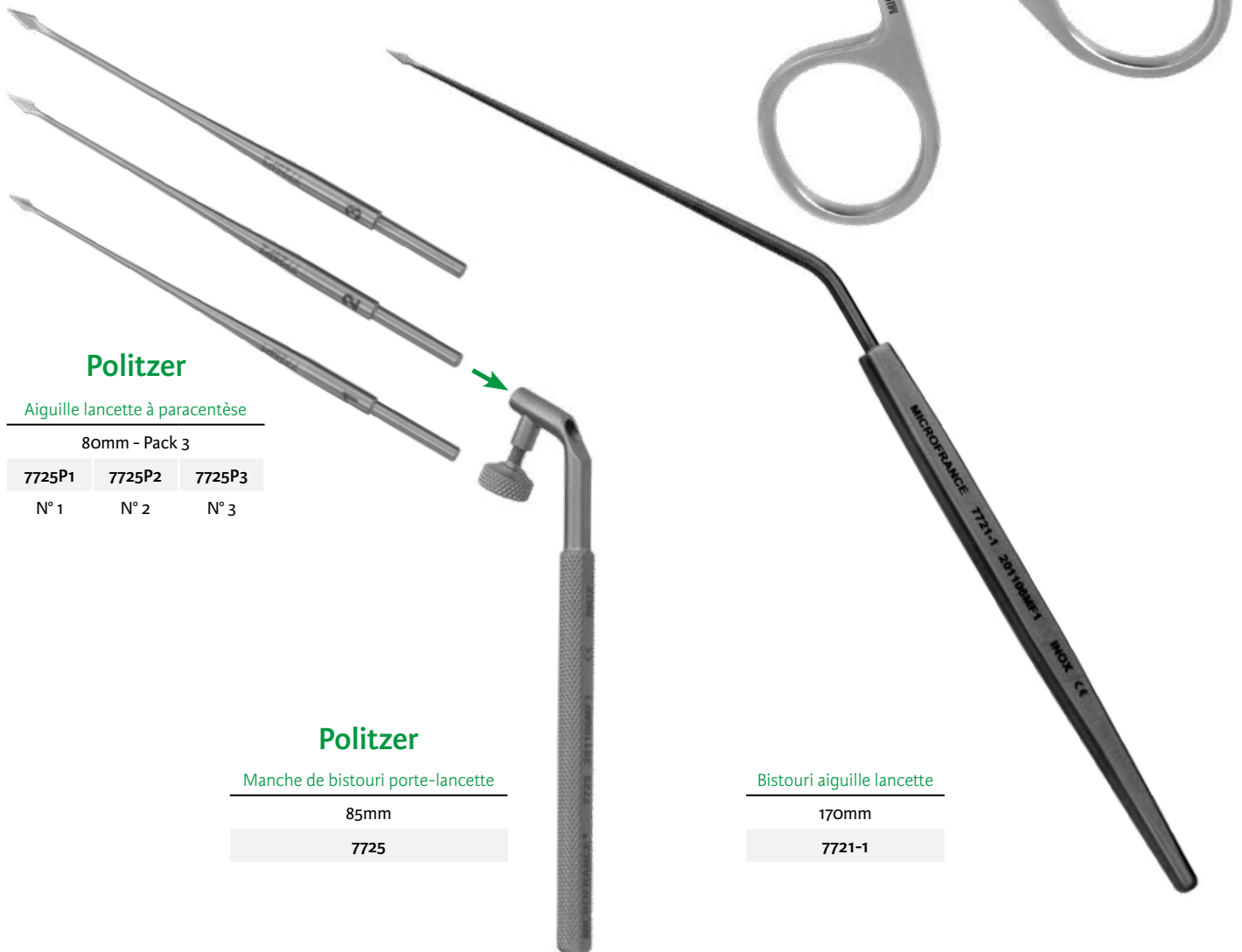

**Politzer**

Aiguille lancette à paracentèse

80mm - Pack 3

7725P1	7725P2	7725P3
N° 1	N° 2	N° 3

**Politzer**

Manche de bistouri porte-lancette

85mm

7725

Bistouri aiguille lancette

170mm

7721-1



3722151

Micro bistouri double 2x3mm à myringoplastie 165mm

3722150

90° et 115°

3722151

25° et 45°

### Manches de bistouri non stériles



### Lames de bistouri stériles, usage unique, Bte 25



<sup>(D)</sup> Distribué par Integra MicroFrance SAS (France) - Voir tableau d'équivalence annexe pour la référence du fabricant correspondante.  
\* Veuillez vérifier auprès de votre représentant commercial la disponibilité de ce produit dans votre pays.

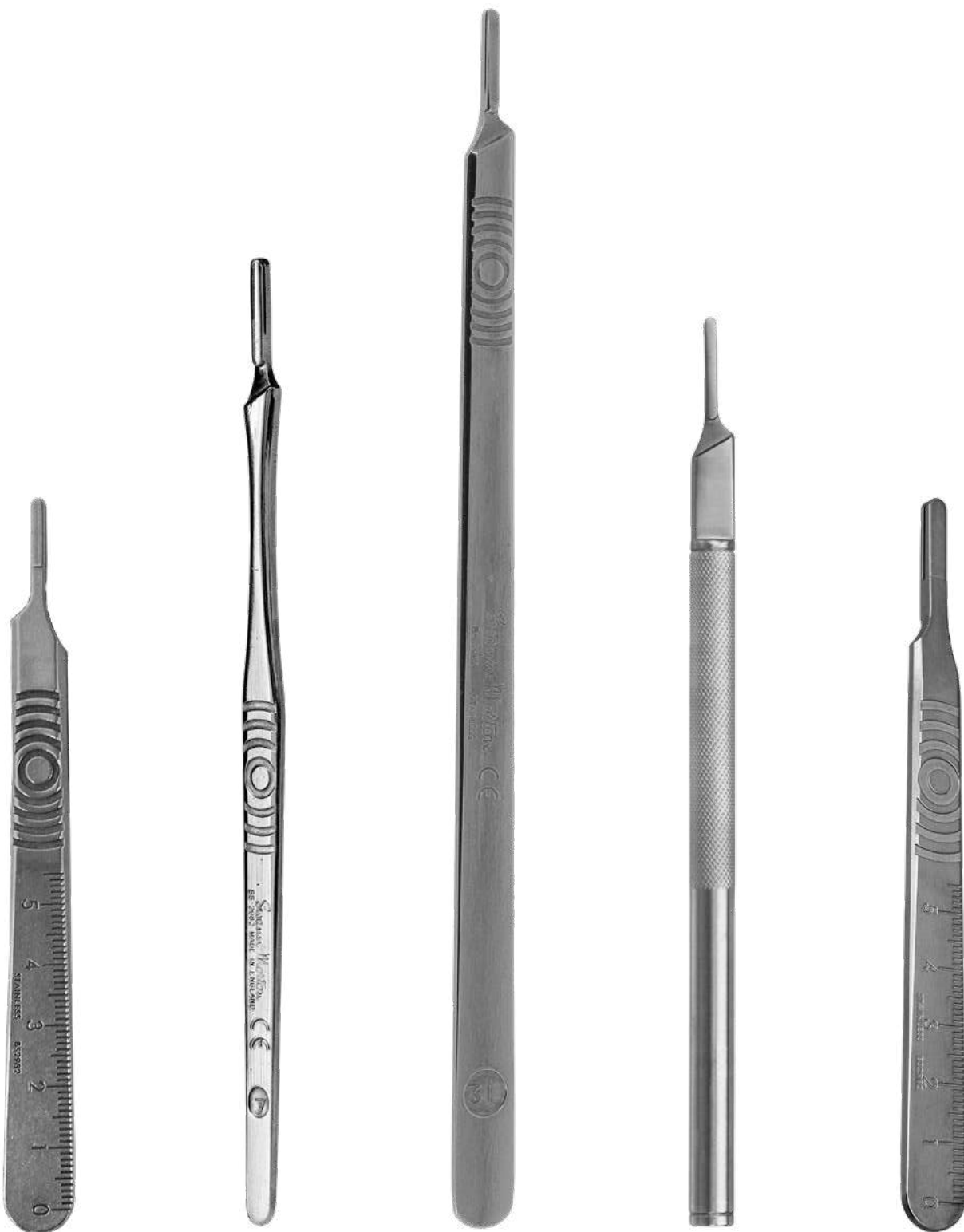

120mm

160mm

200mm

150mm

120mm

1003IG<sup>(D)\*</sup>

1005I<sup>(D)\*</sup>

1003LI<sup>(D)\*</sup>

CP821

1004IG<sup>(D)\*</sup>

N° 3

N° 7

N° 3L

N° 4

Utilisation avec lames 11/15

lames 23

<sup>(D)</sup> Distribué par Integra MicroFrance SAS (France) - Voir tableau d'équivalence annexe pour la référence du fabricant correspondante.

\* Veuillez vérifier auprès de votre représentant commercial la disponibilité de ce produit dans votre pays.

Le Mée



45mm

Legent



40mm

Diamètre	45mm	40mm
	Pack 1, unité	Pack 1, unité / Pack 100 non stérile, emballage individuel
○ 2mm	9913-1 <sup>(D)*</sup>	-
○ 2,5mm	9913-2 <sup>(D)*</sup>	-
○ 3mm	9913-3 <sup>(D)*</sup>	8812-1 / 8814T1
○ 4mm	9913-4 <sup>(D)*</sup>	-
○ 4,5mm	-	8812-2 / 8814T2
○ 5mm	9913-5 <sup>(D)*</sup>	8812-3 / 8814T3
○ 5,5mm	-	8812-4 / 8814T4
○ 6mm	9913-6 <sup>(D)*</sup>	8812-5 / 8814T5
○ 7mm	9912-7 <sup>(D)*</sup>	-
○ 8mm	9912-8 <sup>(D)*</sup>	-
○ 9mm	9912-9 <sup>(D)*</sup>	-

<sup>(D)</sup> Distribué par Integra MicroFrance SAS (France) - Voir tableau d'équivalence annexe pour la référence du fabricant correspondante.

\* Veuillez vérifier auprès de votre représentant commercial la disponibilité de ce produit dans votre pays.



Hartmann

160mm

7898

Tieck-Halle



130mm

7897

Beckman



140mm

7899

Main gauche

Viennois



140mm

MCO233

Dilatateur



140mm

MCO237

Autostatique  
Valves striées

Bras articulé



450mm

**Legent**

Bras articulé complet

MCO980

livré avec MCO981



300mm

**Darrouzet**

Bras articulé complet

MCO978

livré avec MCO978S

Cavalier



CEV984

CEV985

Accessoires pour Bras articulé



Porte-spéculums

MCO981



Rotule articulée

MCO983-4



**Devèze**

Spéculums autostatiques

MCO981D



MCO978S

Lucae



7726MF

Politzer



7732-1

150mm

7726MF	7727	7728
mors striés 1x12mm	mors curettes	mors à griffes

120mm

7732-1	7733	7734
mors striés 1,5x14mm	mors curettes	mors à griffes

### Seringue haute pression luer-lock 5cc



Joint gris embout cône luer

779MF-2

Pack 6



Corps de seringue

779MF-3



Joint blanc piston

779MF-1

Pack 6



Sébileau

Fleury

Freer

Howarth

Cottle

McKenty



190mm

CP985

5mm



180mm

MCO305

8,5mm



160mm

MCO803

2,5mm



185mm

CP611

5mm



220mm

CP625

220mm

CP626



240mm

CP627



Farabeuf



120mm 140mm  
7768 7768-1  
la paire la paire

Desmarres



140mm  
CP822-12  
12mm  
CP822-10  
10mm  
CP822-14  
14mm

Gillies



180mm  
CP17  
3mm  
CP17-1  
2mm

Gillies



145mm  
CP17-3  
2mm  
CP17-2  
3mm

Humby



145mm  
CP628  
5mm

110mm  
CP941  
articulé

**Knapp**



150mm

3714027

8mm

3714028

Mousse



140mm

CP21-3

Pointu

CP21A-3

Mousse

**Volkmann**



150mm

7782-1-2



180mm

CP335

**Senn-Miller**



160mm

CP609

3 griffes pointues

### Weitlaner

110mm

0-28-8



### Schuknecht

130mm

0-28-2



### Weitlaner-Wullstein

130mm

0-28-1

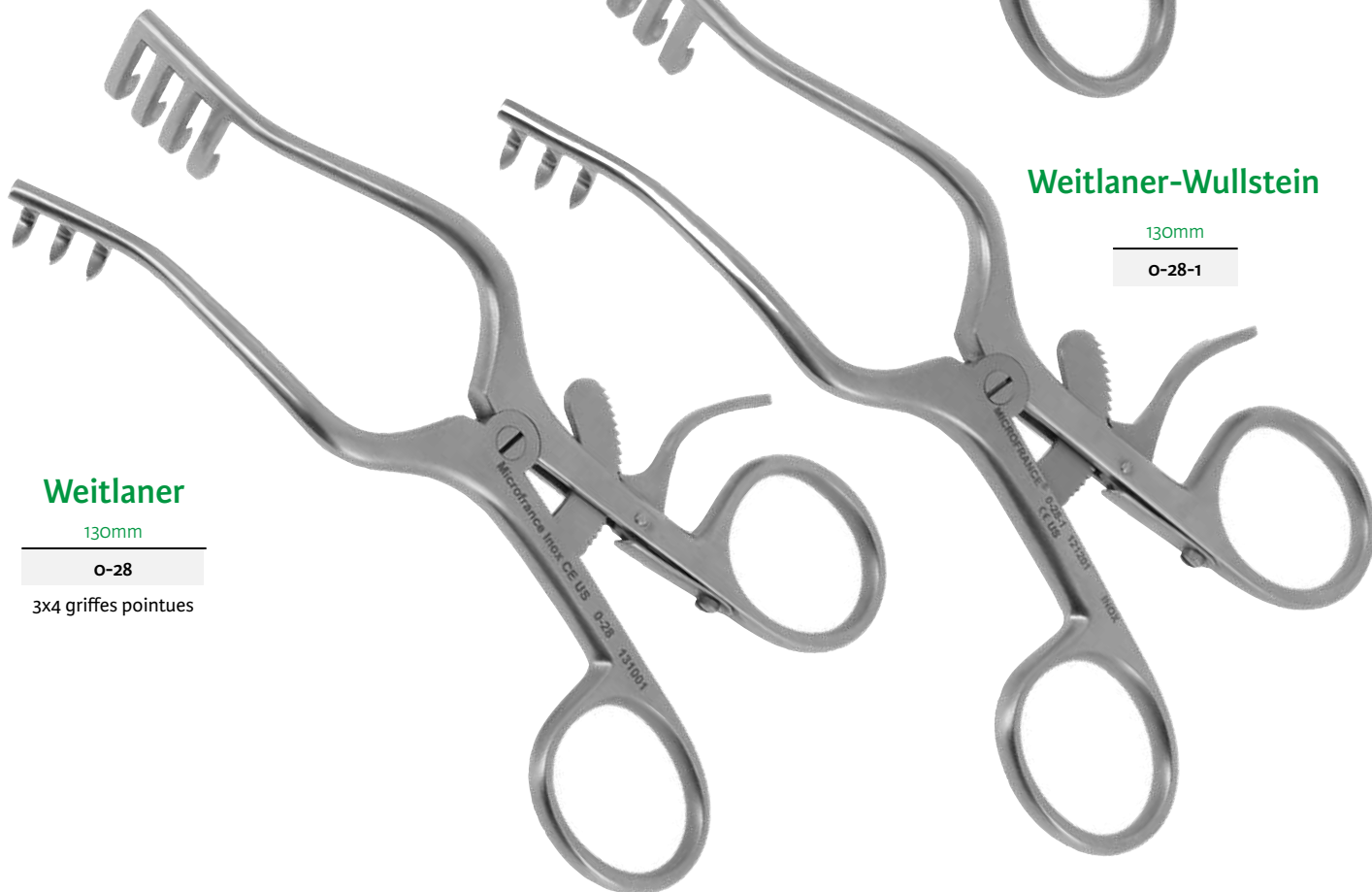

### Weitlaner

130mm

0-28

3x4 griffes pointues

Ecarteur autostatique à spatule



**Plester**

110mm

O-28-3	O-28-4
Griffes pointues à droite	Griffes pointues à gauche



## Weitlaner

Ecarteur courbe

160mm

0-28-7

griffes pointues

**Bizeau**

165mm

**MCL359**

valves 20x30mm

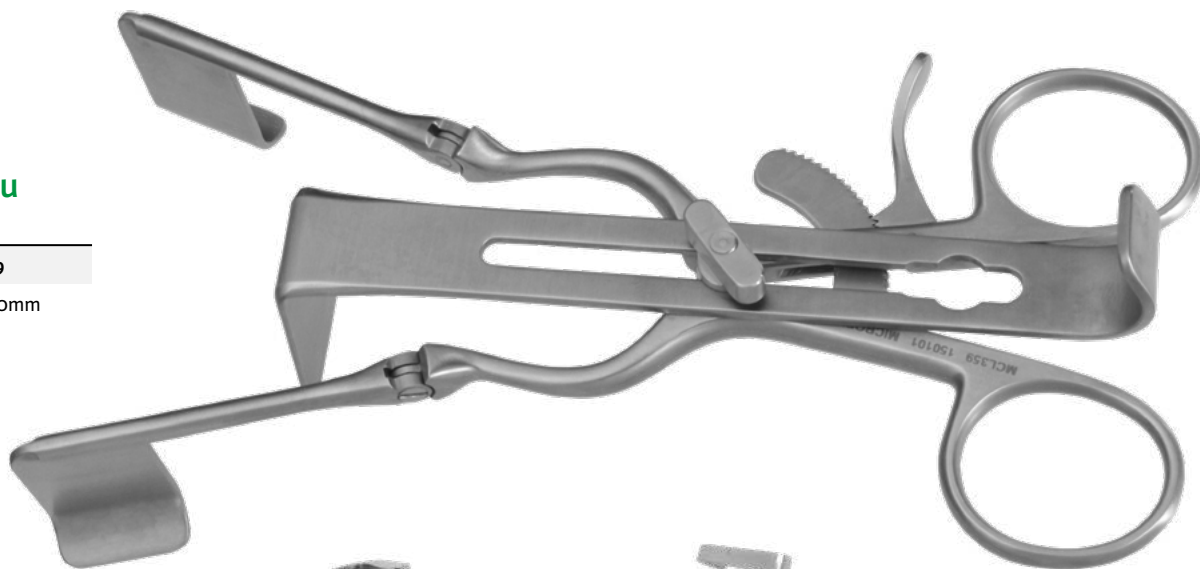

**Weitlaner-Beckmann**

165mm

**7781**





## Lombard

165mm - 110g

MCO995



185mm - 330g

7766

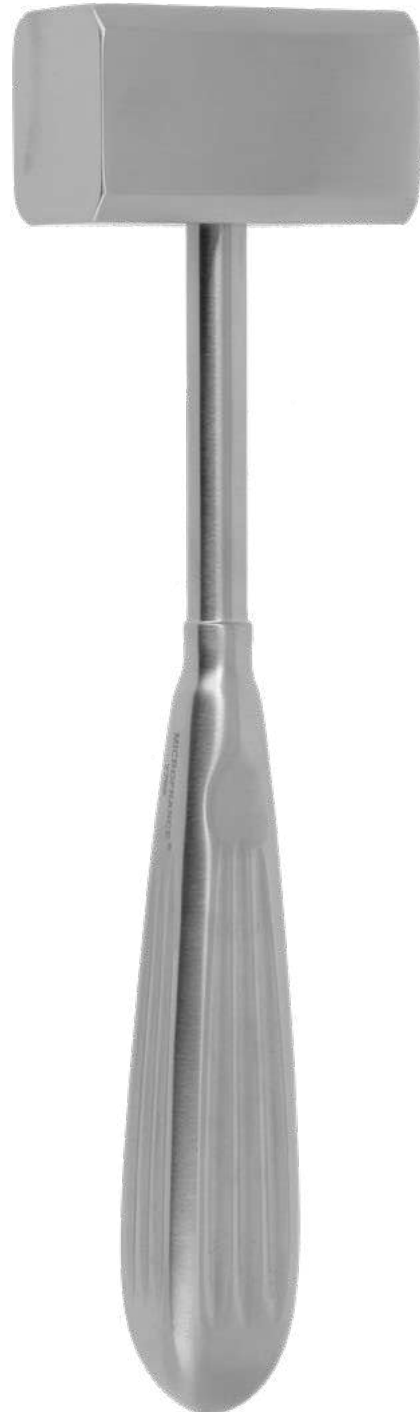

180mm - 200g

**CP907**

1 face téflon



180mm - 230g

**CP300**



Jost



180mm



CP801-7 7mm



CP801-10 10mm

Fleury



150mm

CP823-5 5mm



150mm

CP824-5 5mm



130mm



MCO214-13-10 1mm



MCO214-13-20 2mm



MCO214-13-40 4mm



MCO214-13-60 6mm



MCO214-13-80 8mm

Echelle 1/2

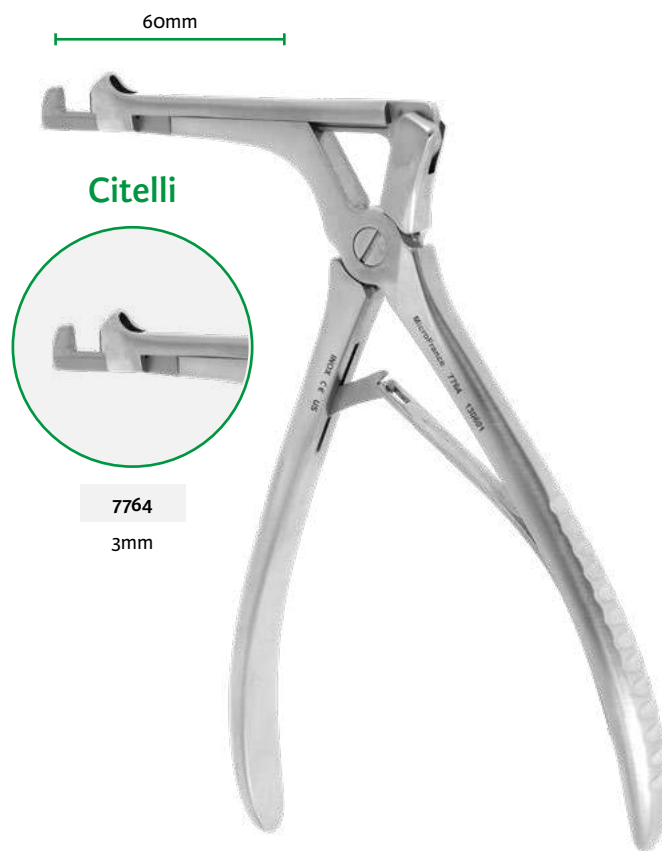



CP380

**Beyer**

160mm

CP380	CP380-2
mors droits 2mm	mors courbes 2mm



CP380-3

**Beyer**

180mm

CP380-3	CP380-5	CP380-1
mors courbes 2mm	mors courbes 4mm	mors droits 2mm

**Streiff**

105mm

CP16-1	CP16
Lames courbes	Lames droites

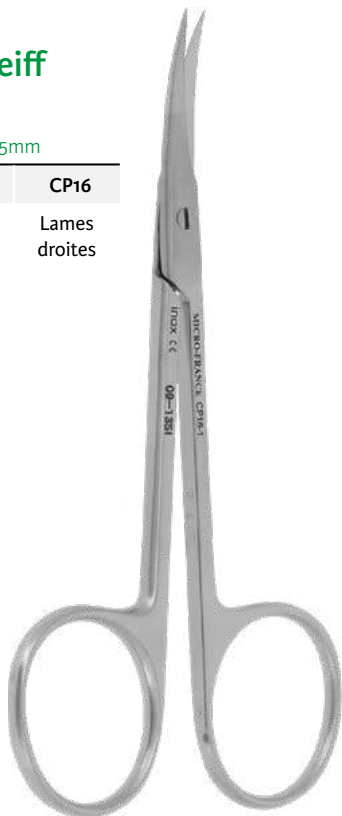

100mm

CP353
forte courbure



**Offret**

100mm

CP356
-------



**Joseph**

120mm

CP354A	CP354
Lames courbes	Lames droites



**Joseph**

110mm

CP919A	CP919
Lames courbes	Lames droites



**Fox**

110mm

CP358A	CP358
Lames courbes	Lames droites

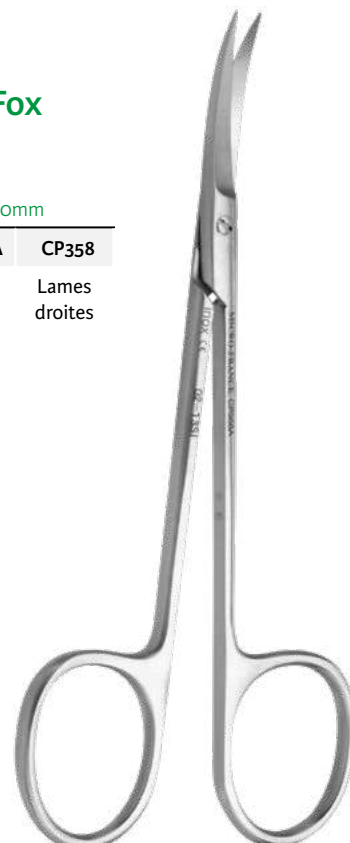

### Shea

120mm

CP637

Lames courbes



### Bregat

110mm

CP363

Lames courbes



### Stevens

110mm

CP922A

Lames courbes

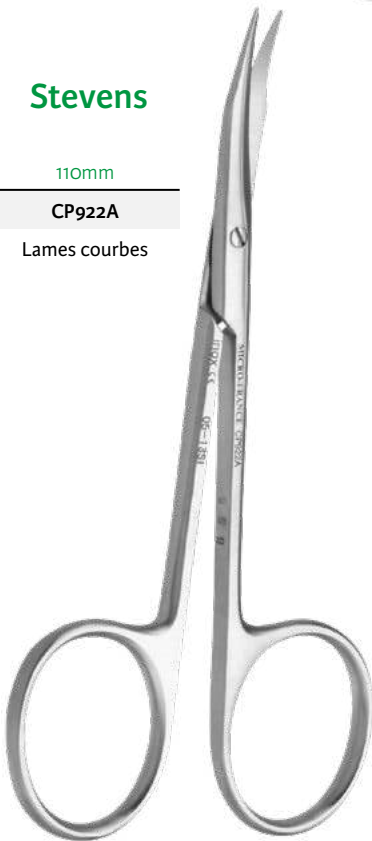

### Stevens

110mm

CP922

Lames droites

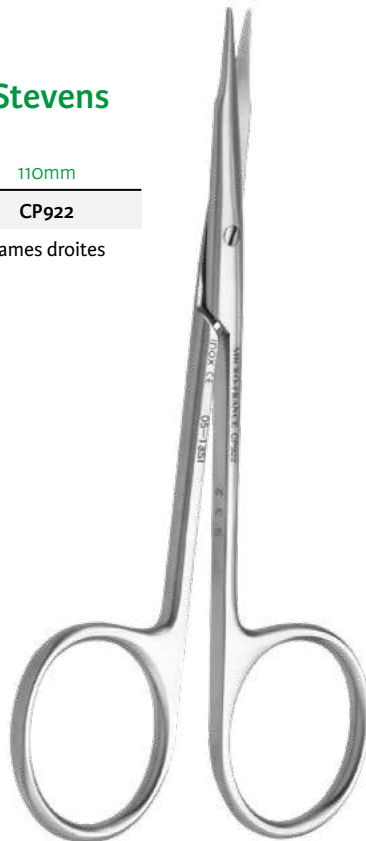

### Stevens

115mm

CP922B

Lames courbes  
modèle «Angers»



**Metzenbaum**

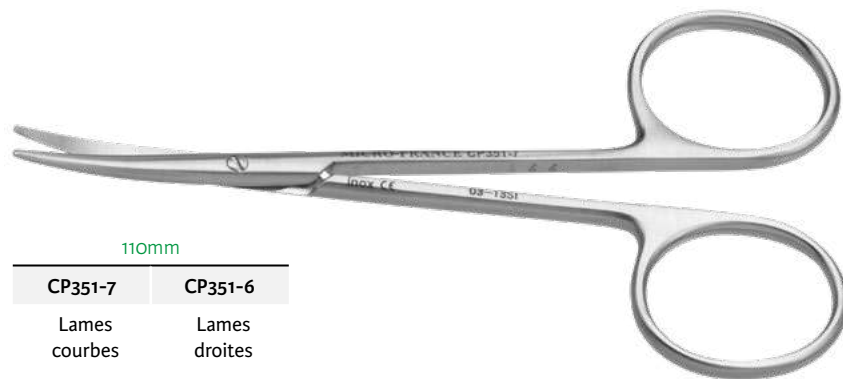

110mm

CP351-7	CP351-6
Lames courbes	Lames droites

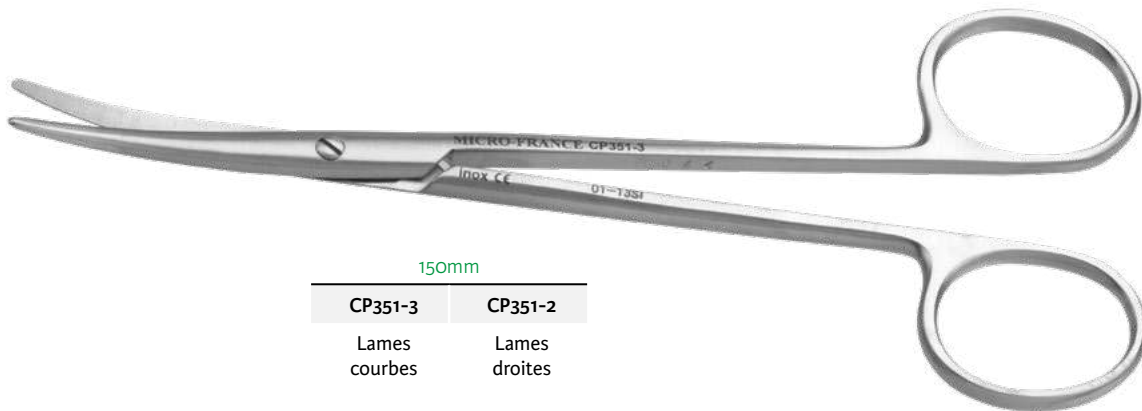

150mm

CP351-3	CP351-2
Lames courbes	Lames droites

**Lames Fines**

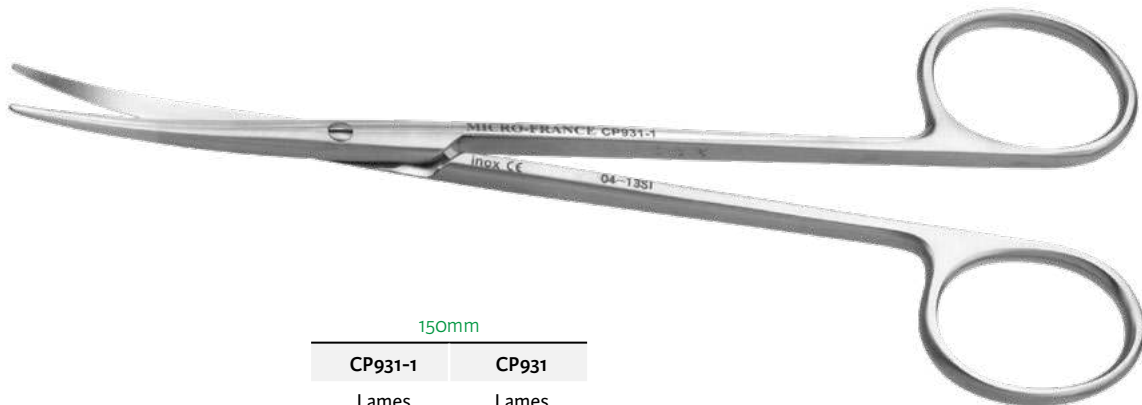

150mm

CP931-1	CP931
Lames courbes	Lames droites



Mayo



170mm

CP352-2

Lames droites



150mm

CP352

Lames droites



170mm

CP352-3

Lames courbes



150mm

CP352-1

Lames courbes

**Pince à disséquer 110mm**

Griffes horizontales et plateaux lisses		CP938-1	<b>Castroviejo</b>
Griffes obliques et plateaux lisses		CP37	<b>Castroviejo</b>
Stries croisées		CP332	mors striés 1,4mm

**Pince à disséquer 120mm**

mors striés		mors à griffes		
CP414	7831A-12	CP406	7833A-12	CP400-1
Mors 1mm	Mors 1,5mm	Mors 1mm	Mors 1,5mm	5x5 griffes

**150mm**

**Adson**



CP604-15

mors striés  
1,5mm

CP605-15

mors à griffes  
1,5mm

**Adson-Brown**



CP606-15

mors 7x7  
griffes

**120mm**



Adson-Tubiana

Adson

Adson-Brown

Mors 1mm		Mors 1,5mm		Mors 1,5mm	Mors 7x7 griffes
M832	M833	CP604	CP605	CP606A	CP606
striés	à griffes	striés	à griffes	striés tungstène	

**Mac-Indoe**

140mm



**CP934** Griffes obliques et plateaux striés



**CP934-1** Plateaux striés

**Debakey**

**Barraya**

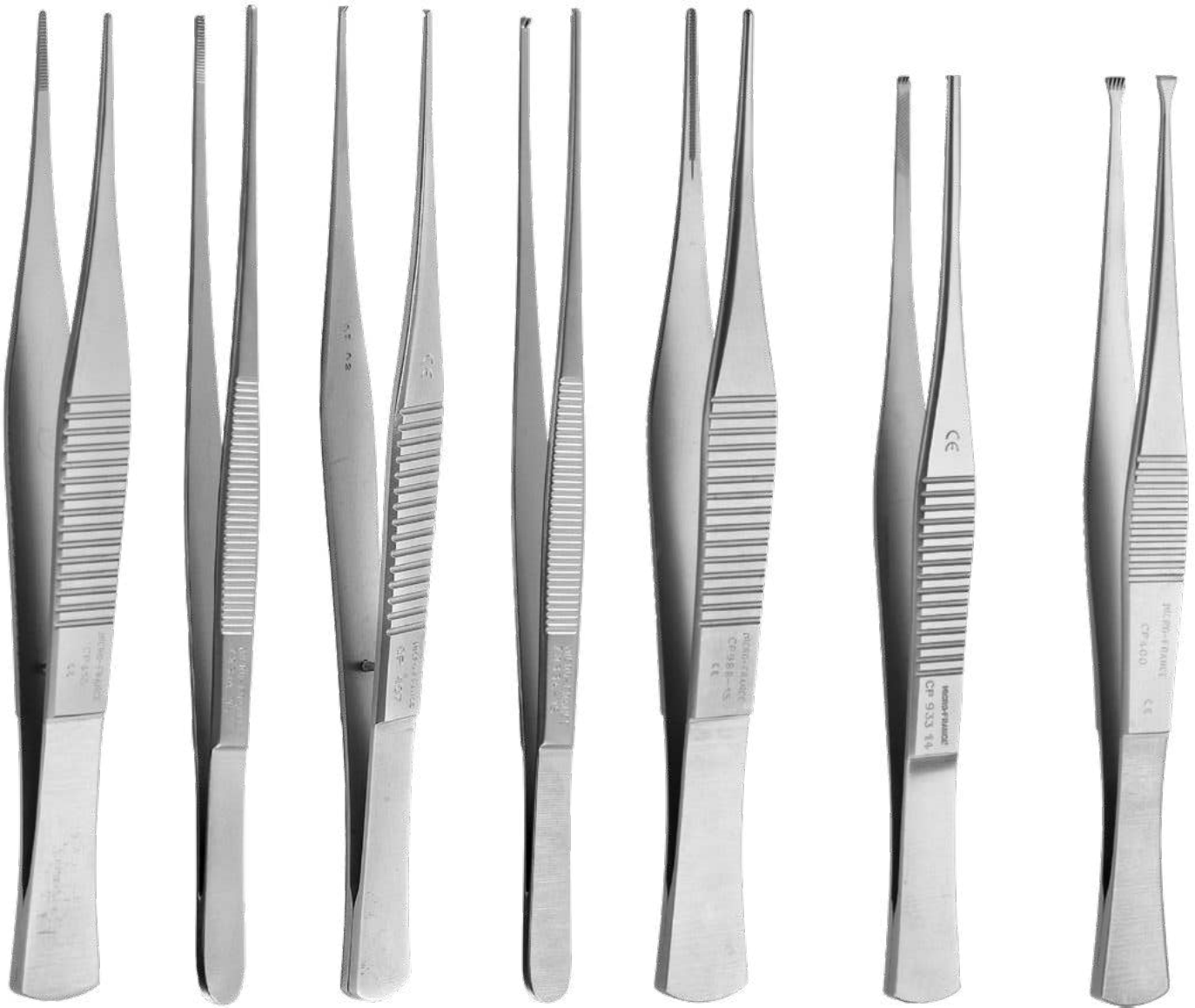

150mm

140mm

<b>CP415</b>	<b>7831A-15</b>	<b>CP407</b>	<b>7833A-15</b>	<b>CP988-15</b>	<b>CP933-14</b>	<b>CP400</b>
Mors striés 1mm	Mors striés 1,5mm	Mors à griffes 1mm	Mors à griffes 1,5mm	Mors 1,5mm	Mors 3x4 griffes et plateaux striés	Mors 5x5 griffes

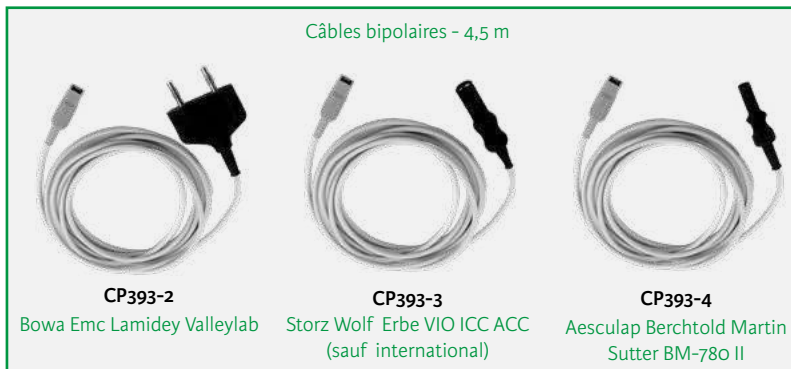

**Magnan**



**Adson**



110mm		120mm		160mm		200mm	
<b>CP392-1R</b>	<b>CP604BR</b>	<b>CP605BR</b>	<b>CP392-2R</b>	<b>CP392-8R</b>	<b>CP392BI</b>	<b>CP392BS</b>	
Mors lisses 1x8mm	Mors striés 1,5mm	Mors à griffes 1,5mm	Mors lisses 1x8mm	Mors lisses 1x8mm	Mors lisses 0,5x5mm	Mors lisses 0,5x5mm	



**Adson**



110mm

**CP390-1**

Mors lisses  
1x8mm



120mm

**CP604M**

Mors striés  
1,5mm



**CP605M**

Mors à griffes  
1,5mm



160mm

**CP390-2**

Mors lisses  
1x8mm



**CP390-8**

Mors à griffes  
1x8mm

Halsey

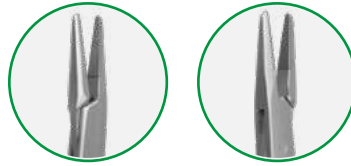

130mm

703T	704T
Mors striés	Mors lisses



703T

Crile-Wood Mayo-Hégar

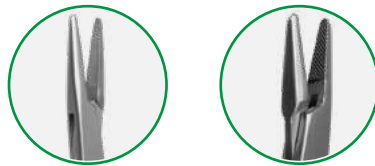

150mm

702T	714T
------	------

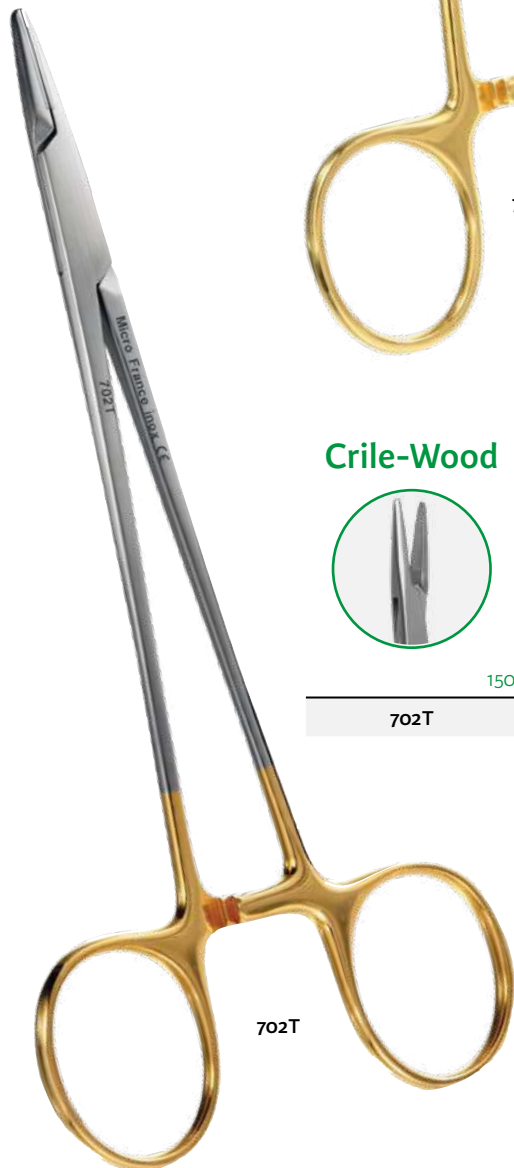

702T

Becker

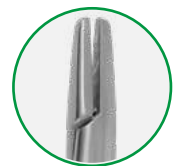

130mm

CP1107
Mors diamantés

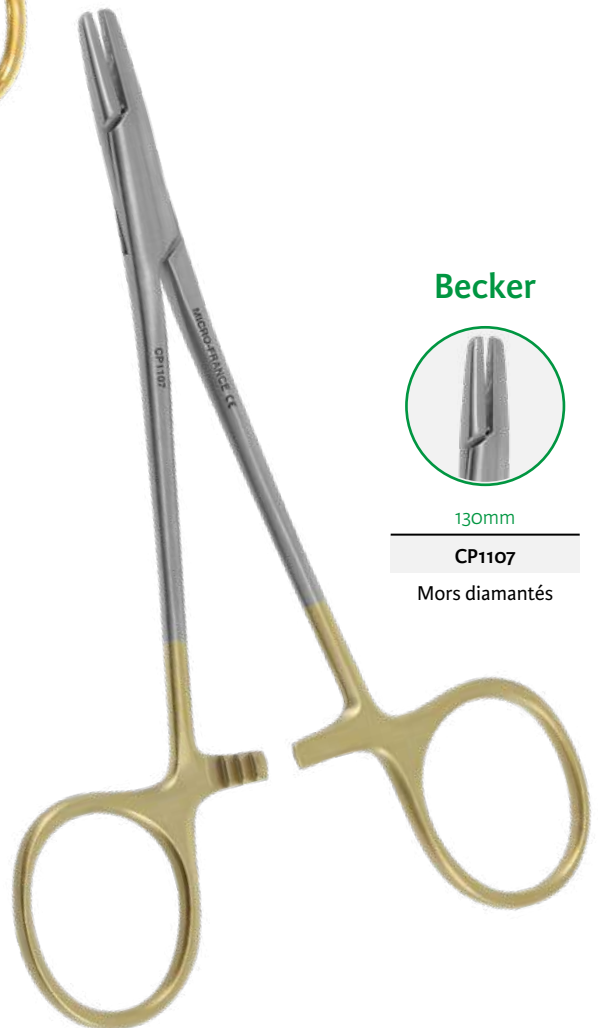



7867-1

### Leriche

140mm - sans griffes

7867-1	7867-2
--------	--------

Droite	Courbe
--------	--------

140mm - à griffes

7867-3	7867-4
--------	--------

Droite	Courbe
--------	--------



P761-7

### Halsted

120mm - à griffes

P761-7	P761-8
--------	--------

Droite	Courbe
--------	--------



### Kelly

sans griffes

140mm 160mm

P762-2 P762-4

Courbe Courbe



P762-2

### Kocher

140mm 160mm 180mm

Droite sans griffes

P764-1 P764-5 -

Droite à griffes

P764-3 P764-7 P764-11



P764-3



### Martel

130mm

P763

Pince striée  
à griffes en «T»

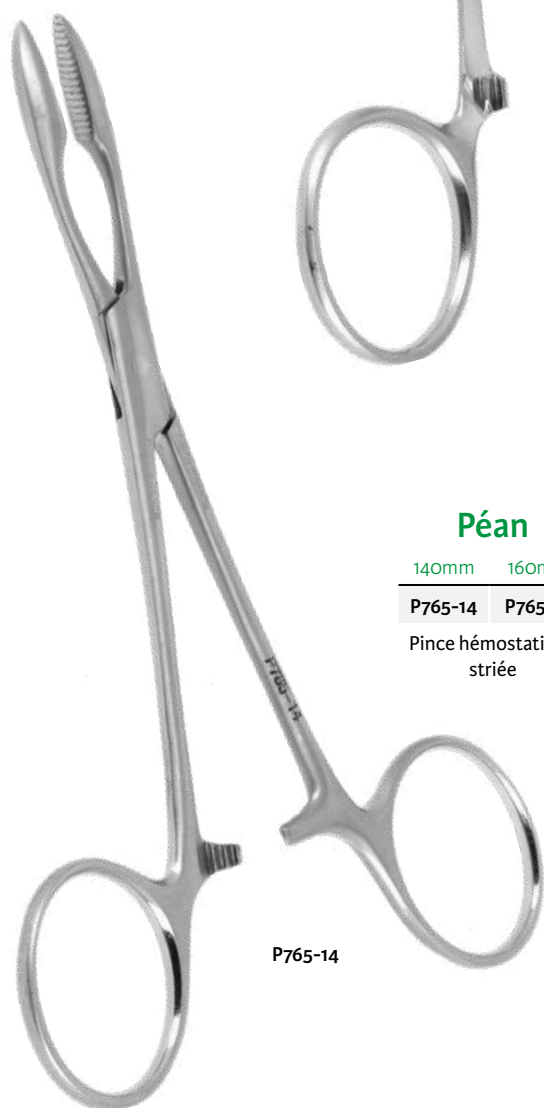

### Péan

140mm 160mm

P765-14 P765-16

Pince hémostatique  
striée

P765-14



### Terrier

130mm

P769

Pince hémostatique  
mors striés

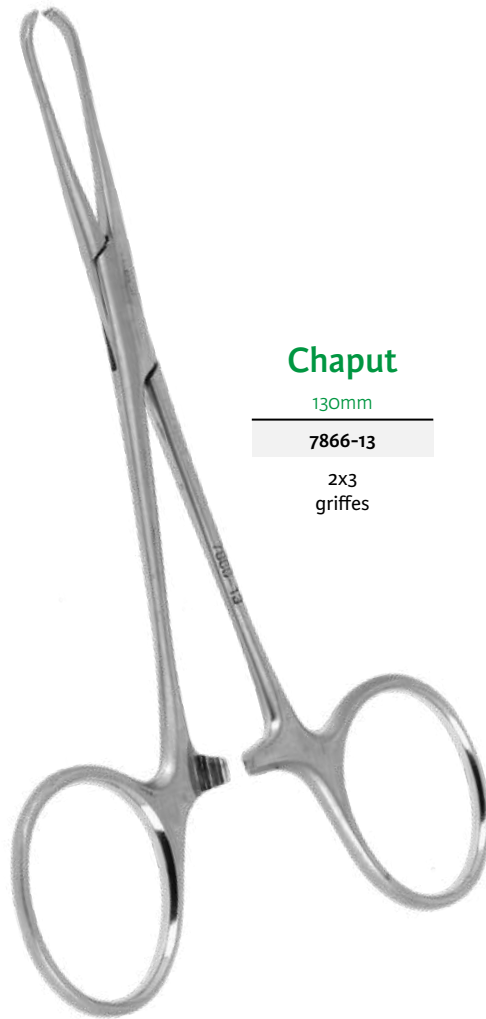

### Chaput

130mm

7866-13

2x3  
griffes

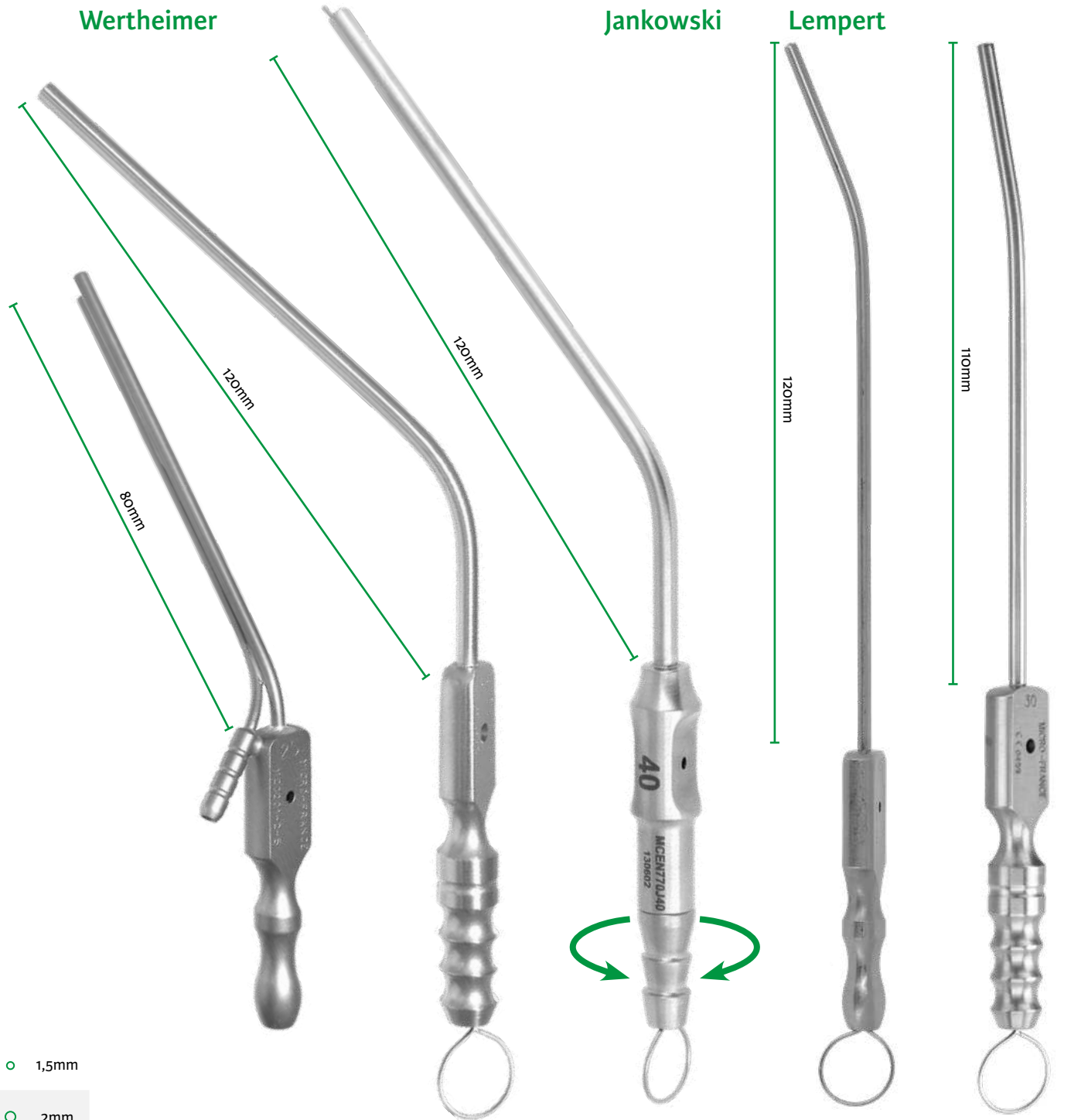

- 1,5mm
- 2mm
- 2,5mm
- 3mm
- 3,5mm
- 4mm

Wertheimer		Jankowski		Lempert		Lempert	
MCO201-2-5	2,5mm	MCEN770J40	4mm	MCO771-2-5	2,5mm	CP330-3-0	3mm
MCO201-3-0	3mm	MCEN770J30	3mm	MCO771-3-0	3mm	CP330-4-0	4mm
MCO770-1-5	1,5mm			MCO771-4-0	4mm		
MCO770-2-0	2mm						
MCO770-2-5	2,5mm						
MCO770-3-0	3mm						
MCO770-3-5	3,5mm						
MCO770-4-0	4mm						

Raccord luer-lock

Manche aspirateur

Benezeth

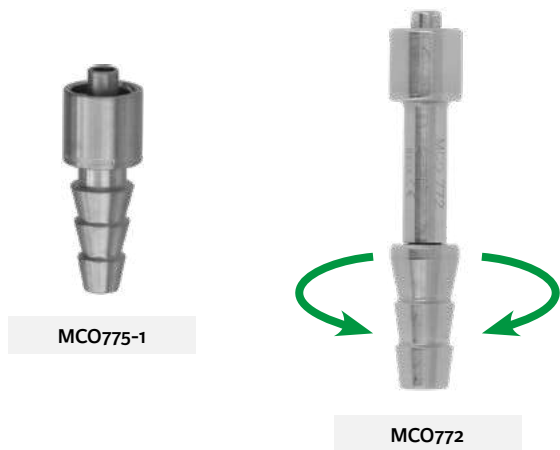

Aspirateurs

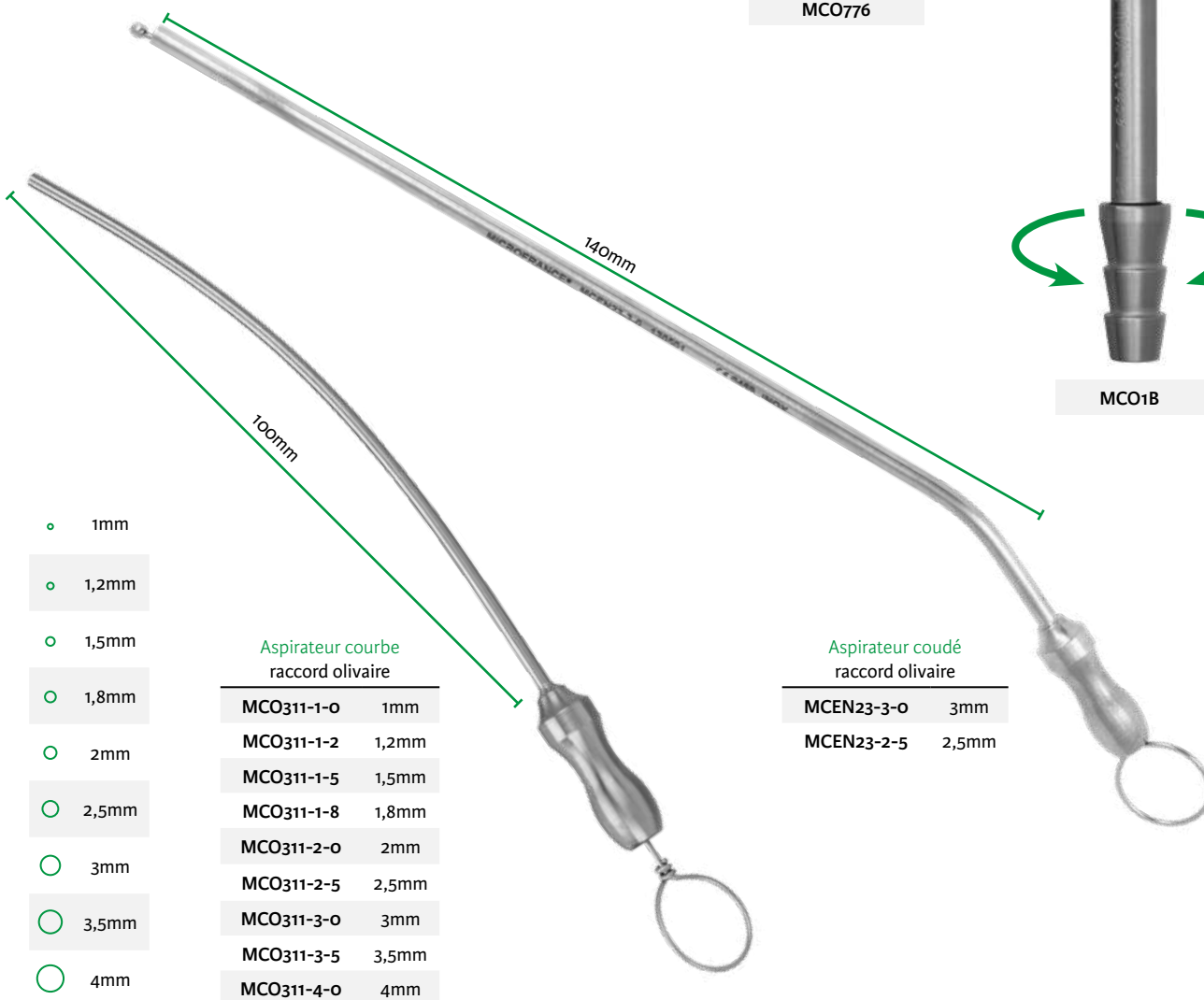

- 1mm
- 1,2mm
- 1,5mm
- 1,8mm
- 2mm
- 2,5mm
- 3mm
- 3,5mm
- 4mm

Aspirateur courbe  
raccord olivaire

MCO311-1-0	1mm
MCO311-1-2	1,2mm
MCO311-1-5	1,5mm
MCO311-1-8	1,8mm
MCO311-2-0	2mm
MCO311-2-5	2,5mm
MCO311-3-0	3mm
MCO311-3-5	3,5mm
MCO311-4-0	4mm

Aspirateur coudé  
raccord olivaire

MCEN23-3-0	3mm
MCEN23-2-5	2,5mm

**Maspetioli**



MCO773

Aspirateur à soupape  
Ø 2,5 mm

MCO773	
raccord luer-lock	
Micro aspirateur pour MCO773	
MCO774-0-4	0,4mm
MCO774-0-5	0,5mm
MCO774-0-6	0,6mm
MCO774D8	0,8mm

**Charachon**



MCO890

Aspirateur à soupape Ø 3mm

MCO890	
Micro aspirateur pour MCO890	
MCO890-1-04	0,4mm
MCO890-1-08	0,8mm
MCO890-1-12	1,2mm
MCO890-1-15	1,5mm
MCO890-1-20	2mm

Rosen

Fraysse

Causse



Pack 3

MCO3P18

Aspirateur coudé  
raccord luer-lock

Pack 3	
MCO3Po5	0,5mm
MCO3Po7	0,7mm
MCO3P10	1mm
MCO3P12	1,2mm
MCO3P15	1,5mm
MCO3P18	1,8mm
MCO3P20	2mm
MCO3P24	2,4mm



MCO366F10

Micro aspirateur rétreint  
à crépine  
raccord luer-lock

MCO366F10	1mm
MCO366F12	1,2mm
MCO366F15	1,5mm
MCO366F20	2mm

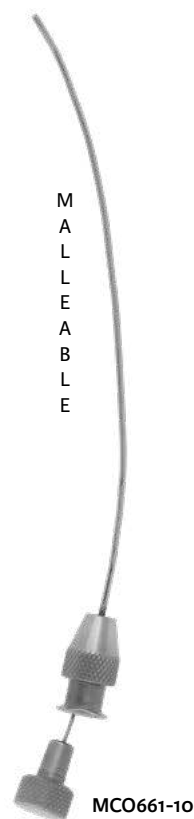

M  
A  
L  
L  
E  
A  
B  
L  
E

MCO661-10

Aspirateur malléable  
raccord luer-lock

MCO661-10	1mm
MCO661-7	0,7mm

**Hartmann**



**MCO13C**  
0,6x3mm



**MCO13A**  
4,5x1mm



**MCO17**  
4x0,8mm  
Ouverture à droite



**MCO13D**  
6x1,3mm



**MCO22**  
6x1,5mm  
1x2 dents



**MCO13B**  
8x1,6mm



**MCO13E**  
0,9x12mm

70mm

**Marquet**



**MCO960**  
0,6x3mm



**MCO961**  
0,6x3mm

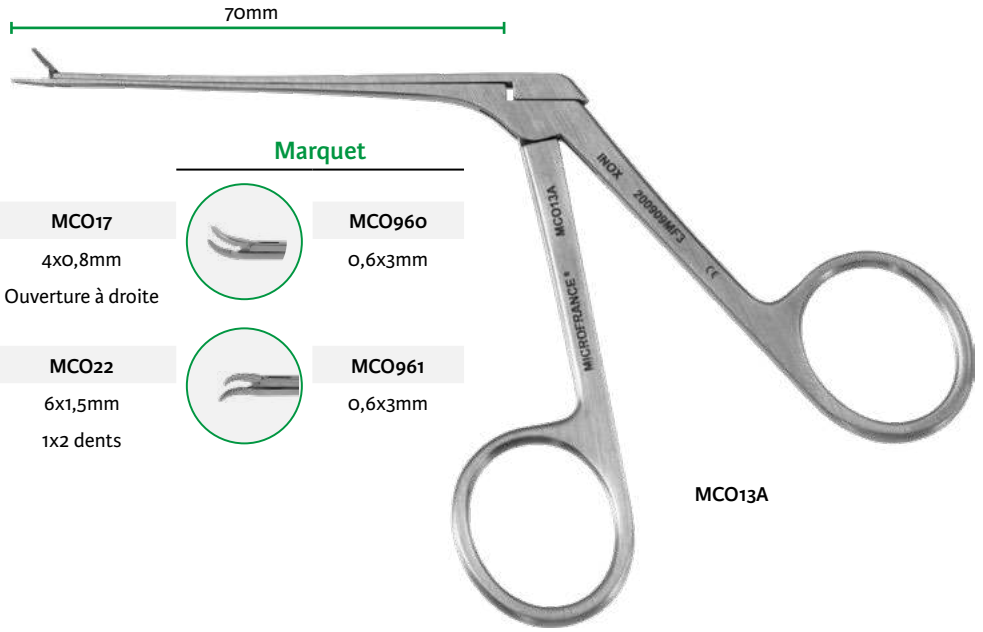

MCO13A

**Pince mors alligator**

100mm



**Martin**  
**MCO23A**  
1,5x8mm

80mm

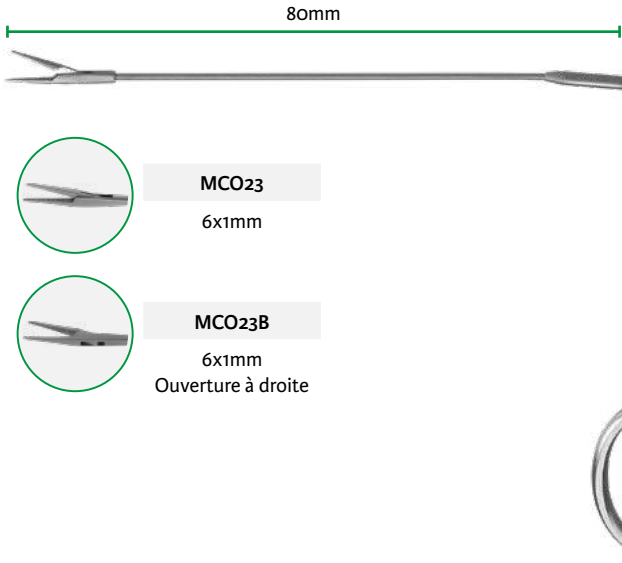

**MCO23**  
6x1mm



**MCO23B**  
6x1mm  
Ouverture à droite

MCO23

MCO23A



Micro ciseaux

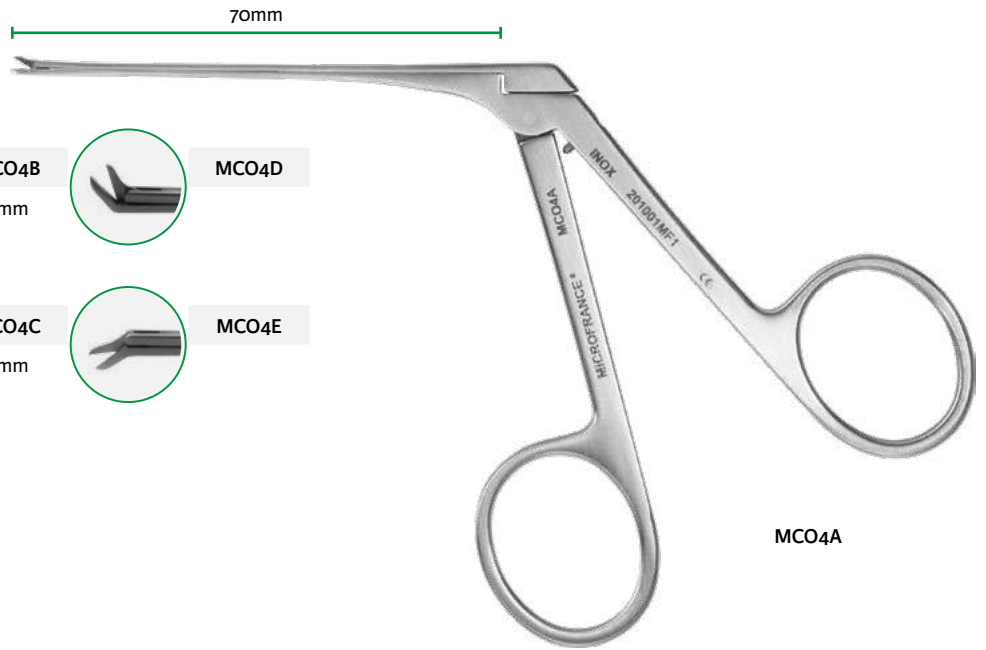
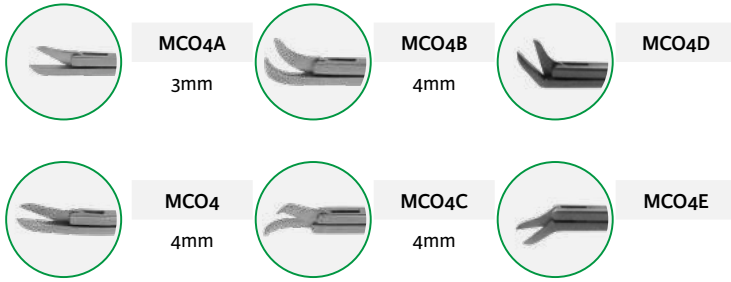

Micro pince curette

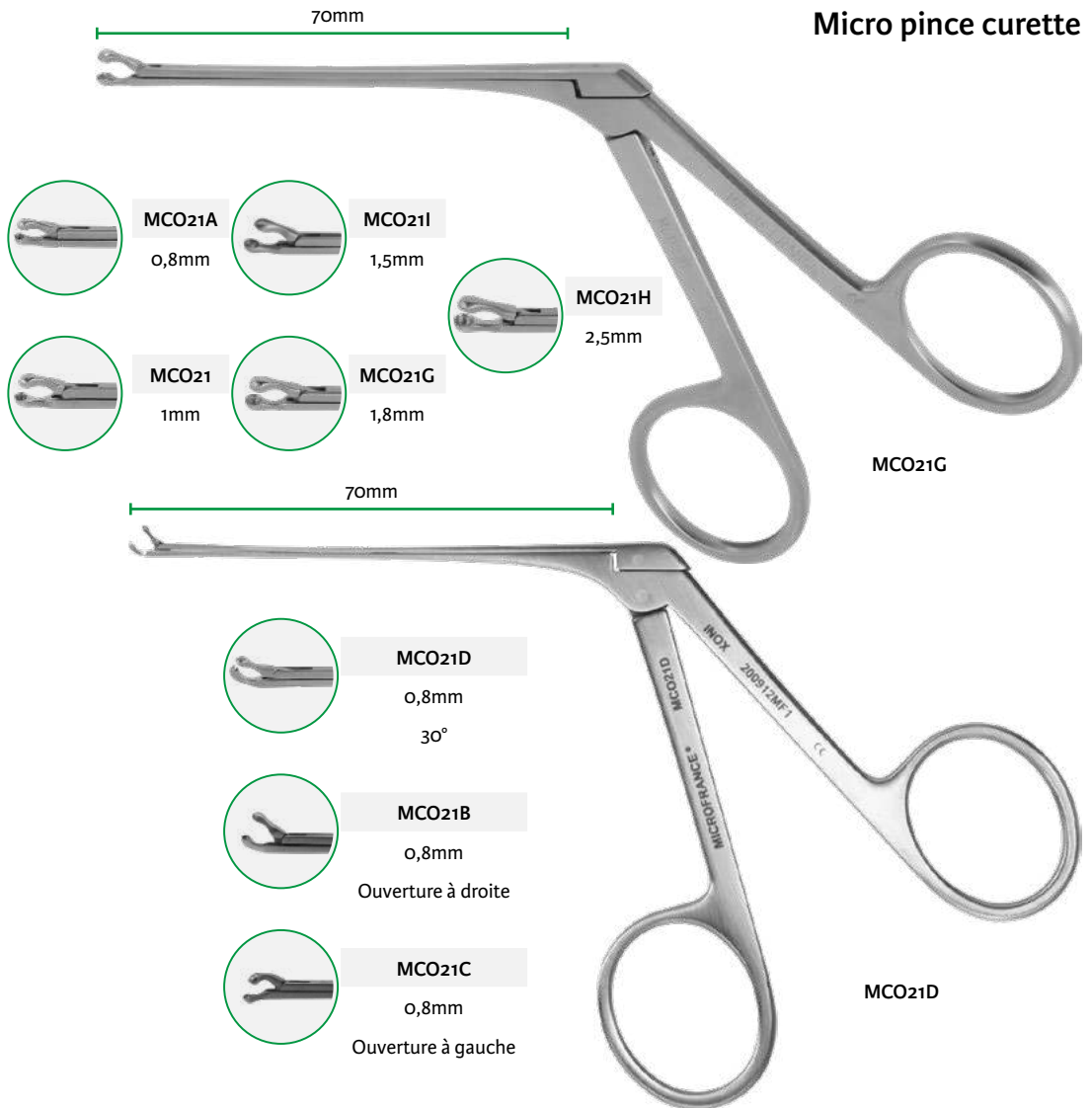

**Kraus**

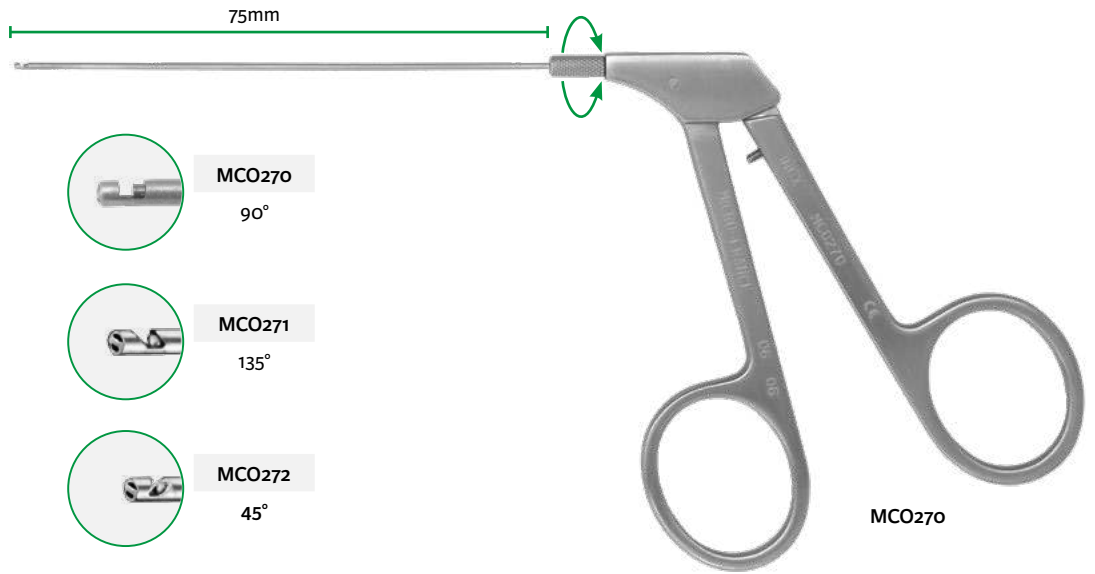

**Dieter**

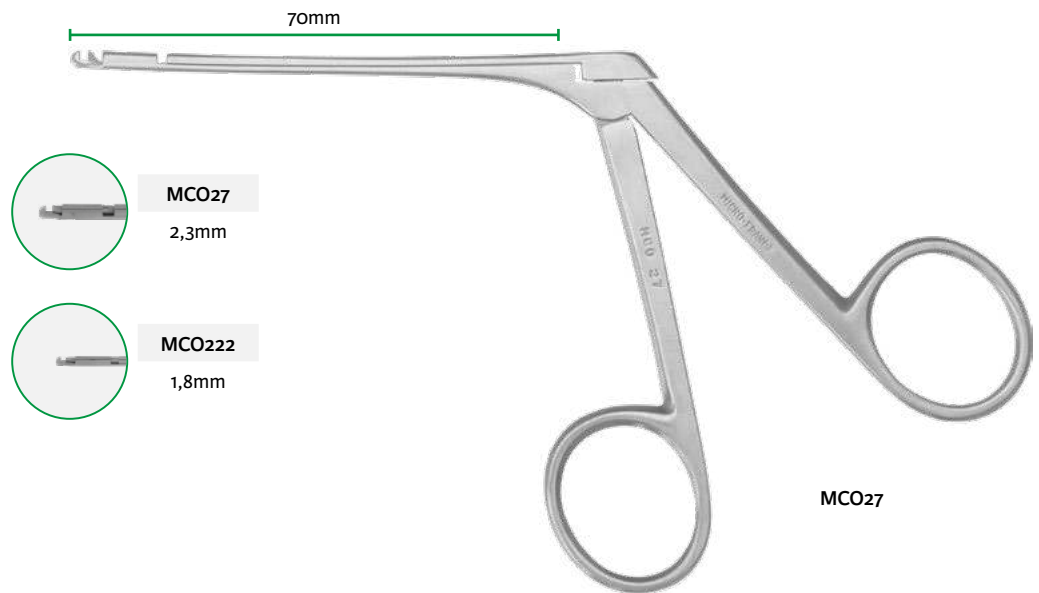

**Dieter-Charachon**

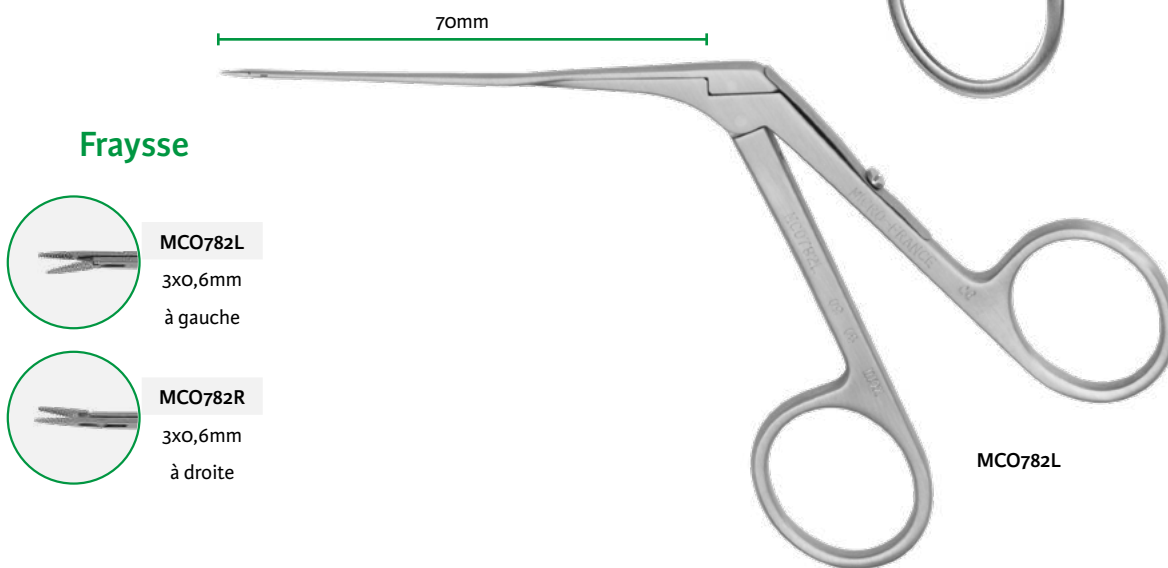
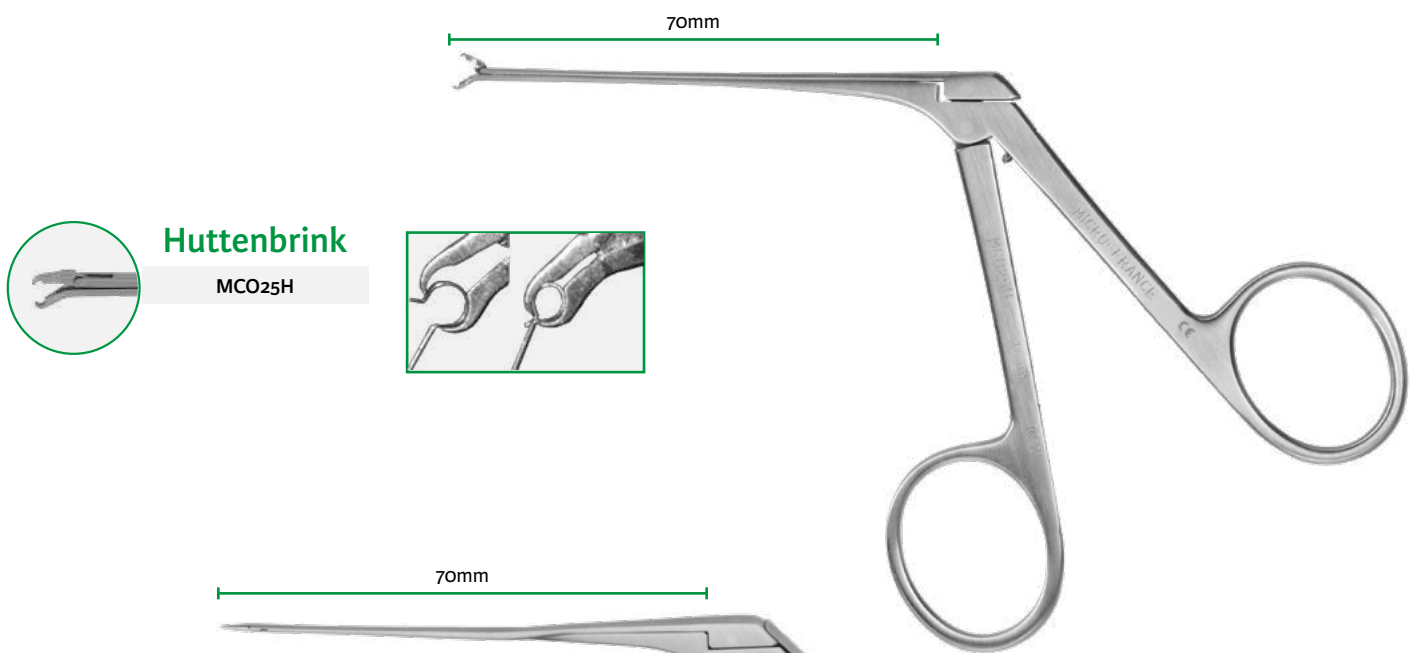
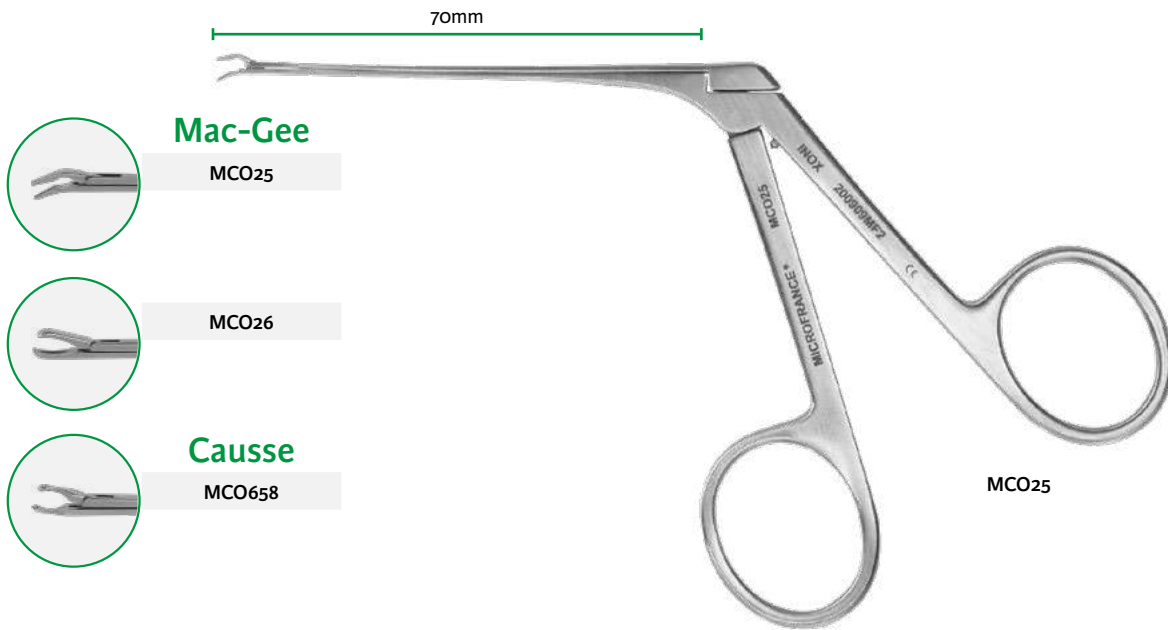



MCO5A-2-5  
165mm

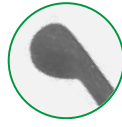
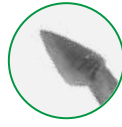

Micro bistouri 45°

Micro bistouri lancéolé

**Cause**

**Martin**

45°

**Rosen**

**Cause**

**Plester**

MCO5A-2-5	2,5mm	MCO652	MCO215	MCO5C	MCO313	MCO653	MCO6
MCO5A-1-0	1mm	3mm	3mm	2,5mm	1,8x2,5mm	1,5x2mm	2x2,5mm
MCO5A-1-5	1,5mm		Bistouri miroir	Déporté			
MCO5A-2-0	2mm						

Micro bistouri falciforme

Micro bistouri lancéolé

Micro ciseau burin

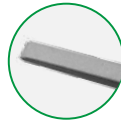
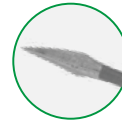
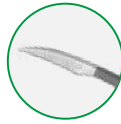
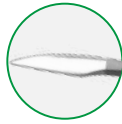

**Rosen**

**Morgon**

**Jost**

MCO10	MCO10B	MCO10M	MCO204C	MCO2
5mm	4,5mm	4mm	2x4mm	1,2mm



MCO650  
165mm



Tige coudée

**Cause**

**Frayse**

**Cause**

**Plester**

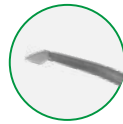
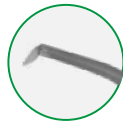
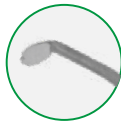

Micro bistouri

Micro bistouri lancéolé

Micro bistouri longitudinal

MCO5B	MCO650	MCO5	MCO651F	MCO651	MCO6C
30° 2,5mm	90° 3mm	90° 2,5mm	90° 1,5x1,5mm	45° 1,5x2mm	30° 2x2,5mm



MCO5E  
165mm

Aspiration



MCO5D  
45°  
2mm

Micro bistouri  
aspirateur à  
soupape

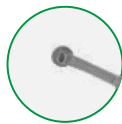

MCO5E  
45°  
3mm

**Josephson**



160mm



Micro faux  
3mm

MCO312  
Instrument double

Micro bistouri  
45°  
1,5x3mm



**Micro miroir**



**Micro rugine**

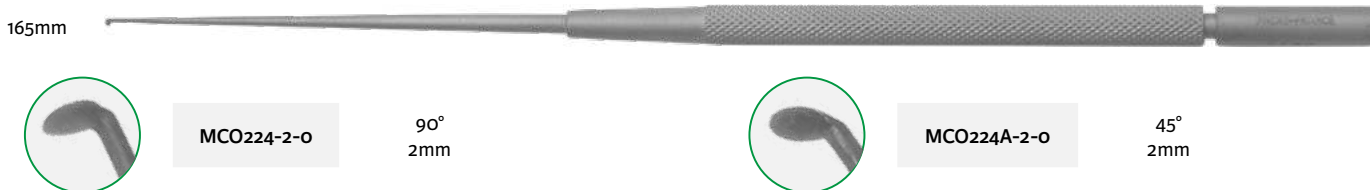

**Micro décolleur coudé**

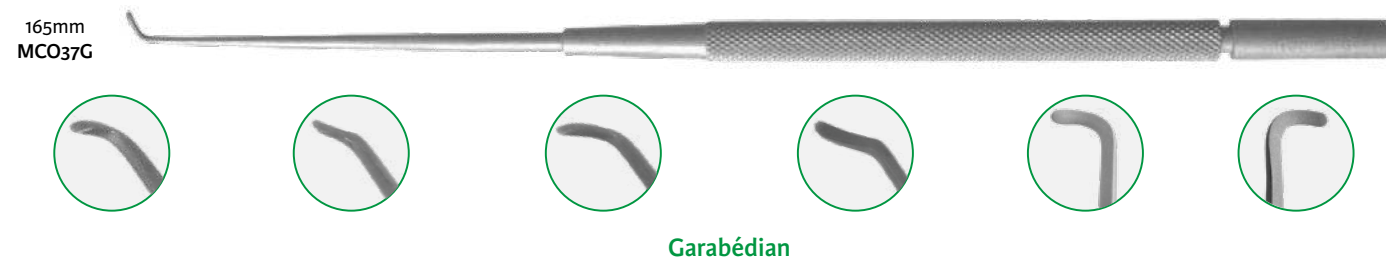

«Canne de golf»

«queue de cochon»

MCO37	MCO37-1	MCO37D	MCO37G	MCO905	MCO906
coudé à droite	coudé à gauche	coudé à droite	coudé à gauche	coudé à droite	coudé à gauche

**Micro décolleur courbe - coudé**

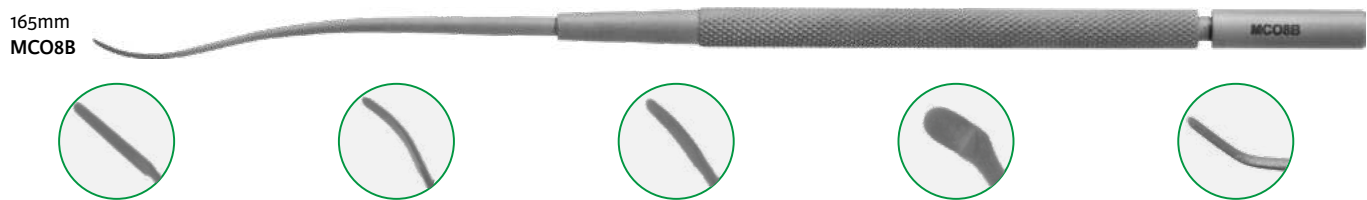

**Gimmick**

Coudé 15°

Courbe

Courbe à Sulcus

**Causse**

Coudé 45°

Coudé 45°

MCO8	MCO8B	MCO817	MCO667	MCO210
1,5x15mm	1,5x15mm	1,7x7mm	2x3mm	0,75x4mm

**Micro décolleur double**





**A**  
Curette droite de Volkmann 170mm

0	CP302-2	2mm
0	CP302-3	3mm
0	CP302-4	4mm
0	CP302-5	5mm
0	CP302-6	6mm
0	CP302-8	8mm

**B**  
Micro curette fenêtrée 165mm

	MCO207-1-5	1,5mm
	MCO207-2-0	2mm

**C**  
Micro curette double droite 170mm

	MCO7-1	2,2 / 2,5mm n° 1/2
	MCO7-3	1,5 / 1,9mm n° 3/4

**D**  
Micro curette double angulée 155mm

	MCO7A-1	2,2 / 2,5mm n° 1/2
	MCO7A-3	1,5 / 1,9mm n° 3/4
	MCO7A-5	1 / 1,2mm n° 5/6

**E**  
Micro curette double 155mm

**Romanet**

	MCO7A6	angulée 1,7x3,2 / 1,3x2,3mm
--	--------	-----------------------------------

**F**  
Micro curette angulée 160mm

**Causse**

	MCO655	2,8mm 45°
--	--------	-----------

**G**  
Micro curette droite 170mm

	MCO818	2,5mm
--	--------	-------

Micro pointe

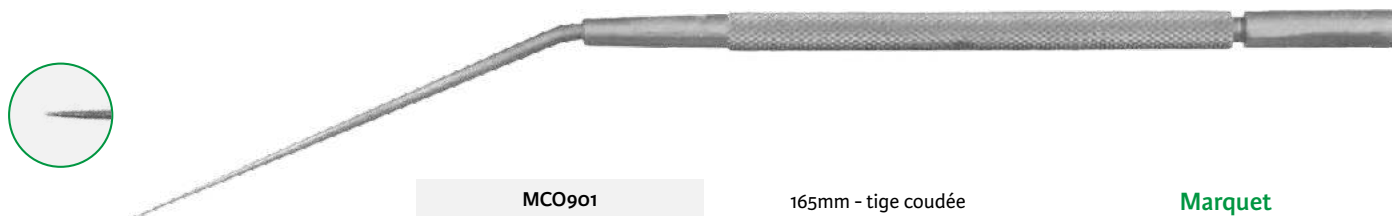

Marquet



Charachon



Cause



Cause

Micro palpateur













Sterkers

### Micro crochet tige droite

165mm  
MCO6A







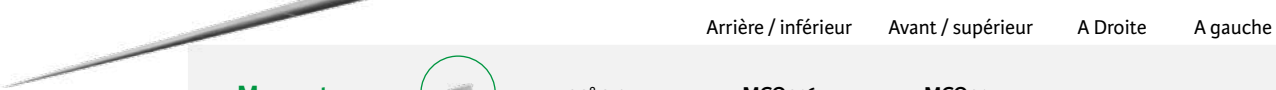

								
45°	MCO6A 0,7mm	Charachon 2mm	Legent 1mm		Marquet	Causse	Causse	Causse
								
90°	MCO205 0,3mm	MCO6B 0,7mm	MCO806A 2mm	MCO806B 4mm	MCO950 0,8mm	MCO654-1 1,2mm - à droite	MCO654-2 1,2mm - à gauche	MCO841

### Micro crochet tige coudée

165mm



				Arrière / inférieur	Avant / supérieur	A Droite	A gauche
Marquet		90° 0,2mm	MCO916	MCO915			
Charachon		90° 0,2mm tige renforcée	MCO832A	MCO832B	MCO832C	MCO832D	
		90° 0,3mm	MCO205A	MCO205B	MCO205C	MCO205D	
Causse		0,2mm	MCO663-2	MCO663-1			
Causse		0,4mm	MCO662-2	MCO662-1			
Causse		90° 0,4mm		MCO664			
Causse		90° 0,7mm		MCO665			
Marquet		45° 0,9mm		MCO920			

### Micro crochet tige extrémité coudée

165mm



Poncet		90° 0,5mm	MCO226A	MCO226	MCO226B	MCO226C
			Arrière / inférieur	Avant / supérieur	A Droite	A gauche



**Micro désarticulateur**

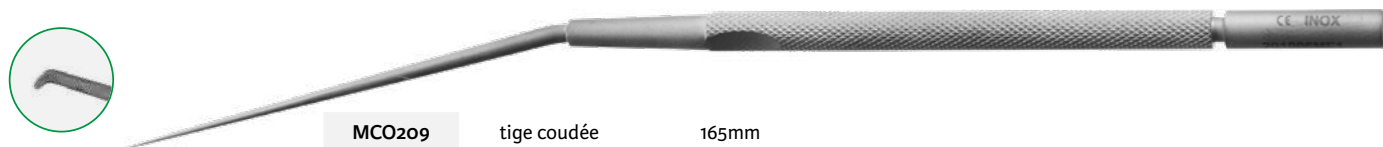

MCO209 tige coudée 165mm



MCO656 45° 165mm

**Cause**

**Désépithélisateur**

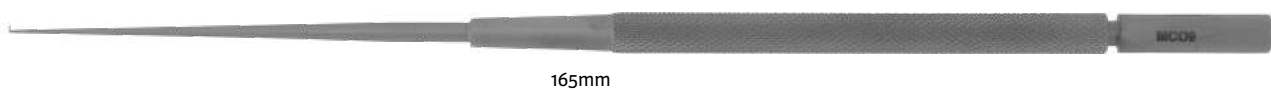

MCO9 90° 165mm

**Micro crochet - Micro rugine**



MCO9-1 Rugine 90° 165mm

**Thomassin**

MCO804 Crochet 90° 0,7mm

**Thomassin**

**Micro instrument manche cuillère**



**Portmann**

Micro pointe droite



MCO970

Micro crochet 90°



MCO971T crochet avant 0,8mm



MCO973T crochet avant 0,3mm



Décolleur courbe monopolaire



MCO8BM

Bordure

140mm

Pointe monopolaire courbe mousse

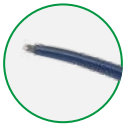

MCO989

Legent

180mm

Câbles monopolaires - 3,5 m



**CP391E**  
Erbe ACC ICC/VIO  
Storz Wolf



**CP391M**  
Aesculap Berchtold Lamidey Martin  
Erbe T Serie Sutter BM-780 II



**CP391V**  
Bowa Bovie Conmed Valleylab

Pince bipolaire

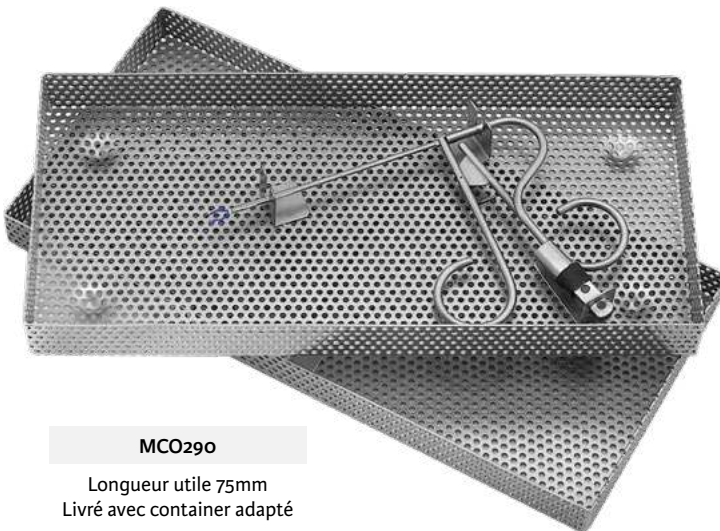

MCO290

Longueur utile 75mm  
Livré avec container adapté

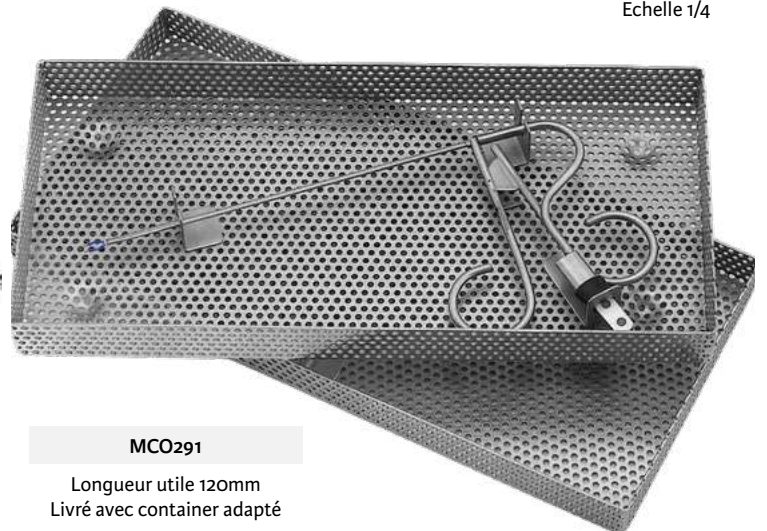

MCO291

Longueur utile 120mm  
Livré avec container adapté

Echelle 1/4

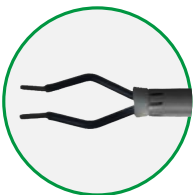

Câbles bipolaires - 4,5 m



**CP393-2**  
Bowa Emc Lamidey Valleylab



**CP393-3**  
Storz Wolf Erbe VIO ICC ACC  
(sauf international)



**CP393-4**  
Aesculap Berchtold Martin  
Sutter BM-780 II

**Micro mesureur tige coudée**

165mm  
MCO12B

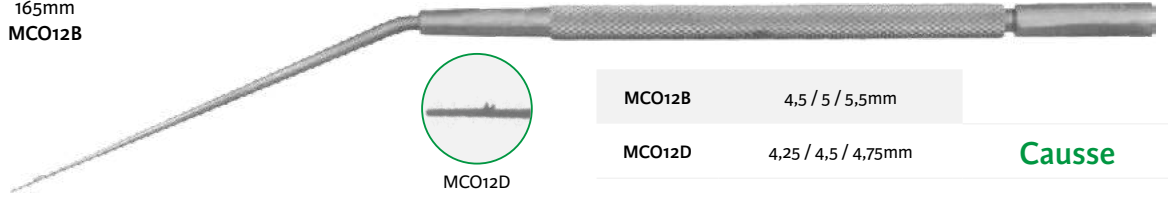

MCO12B 4,5 / 5 / 5,5mm

MCO12D 4,25 / 4,5 / 4,75mm

**Causse**



MCO12E 5 / 6 / 7 / 8mm

MCO12H 3,5 / 4 / 4,5mm

**Vincent**



MCO38 Micro fenestrometer

165mm

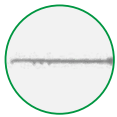

MCO12R tige malléable

3 / 4 / 5mm

**Robier**

165mm

Micro mesureur livré avec protection

malléable

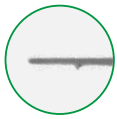

MCO830

tige droite

3,5 / 4 / 4,5mm

**Charachon**

165mm

**Micro mesureur à ossiculoplastie**

MCOR45  
165mm



MCOR20	MCOR25	MCOR30	MCOR35	MCOR40	MCOR45	MCOR50	MCOR55	MCOR60	MCOR65	MCOR70	MCOR75	MCOR80
2mm	2,5mm	3mm	3,5mm	4mm	4,5mm	5mm	5,5mm	6mm	6,5mm	7mm	7,5mm	8mm

**Micro mesureur à mesurer la columelle**

Echelle 2/3

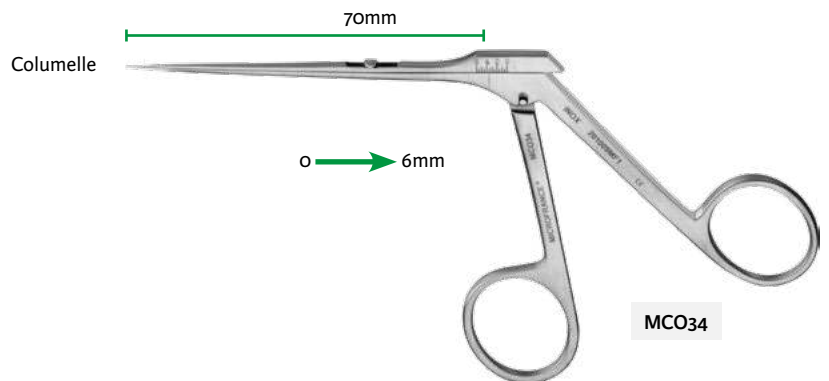
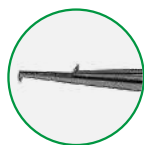

MCO34

**Micro mesureur à ossiculoplastie**

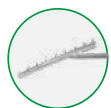

1 → 10mm

MCO844

Sauvage

165mm



**Micro fourche**

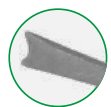

MCO997

Legent

165mm



**Micro Punch pour silastic**



Vincent

MCO571

Ø 2,5 - 0,8mm  
pour silastic 1128305

**Modeleur de Schucknecht**



MCO985 Modeleur

Echelle 1/3

### Presse-greffe écraseur

**Martin**



MCO819



MCO820

### Gabarit découpeur à cartilage

**Teixido**



MCO255

Coupe de 0,3mm

**Martin**

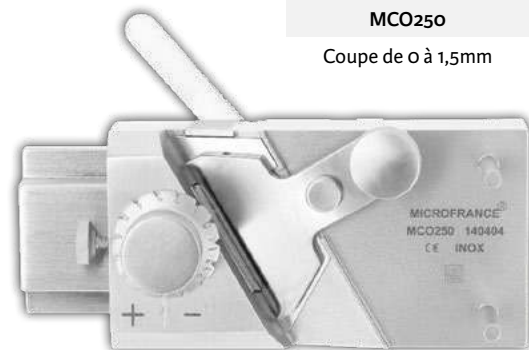

MCO250

Coupe de 0 à 1,5mm



Lame de remplacement

MCO251

Pack 10

Micro perforateur



MCO218-4	0,4mm
MCO218-6	0,6mm
MCO218-8	0,8mm

forme pointe

165mm

Gabarit à piston

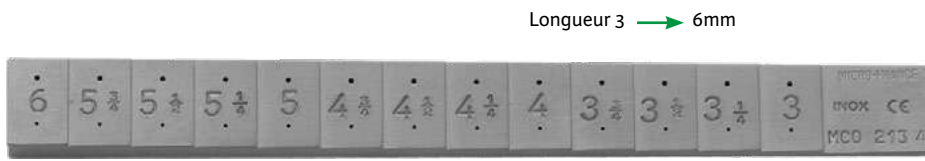

MCO213-4	∅ 0,4 / 0,6mm
MCO213-6	∅ 0,6 / 0,8mm

Plaque lisse



Cause

Plaque minérale verre

65x65x4mm

avec trou

MCO660-10	Trou 1mm
MCO660-12	Trou 1,2mm
MCO660-8	Trou 0,8mm

Sans trou

MCO660-2	65x65x2mm
----------	-----------

Otoplastie

Echelle 1/1

**Stenstrom**



Râpes  
160mm  
2x8mm

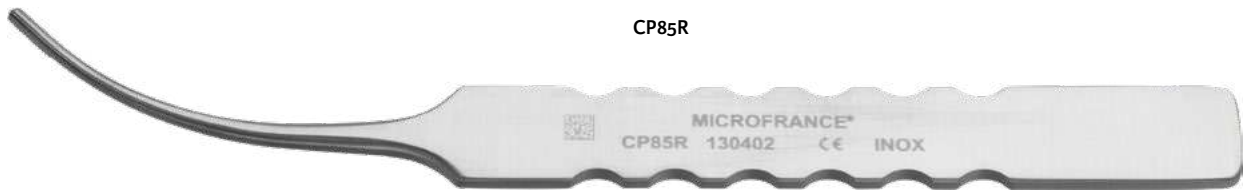

CP85R

MICROFRANCE®  
CP85R 130402 CE INOX

CP85R

Courbe à droite

CP85L

Courbe à gauche

**Stenstrom**

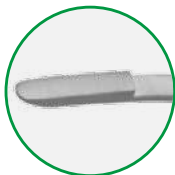

Décolleurs  
160mm  
2x8mm



CP85AL

MICROFRANCE®  
CP85AL 130402 CE INOX

CP85AR

Courbe à droite

CP85AL

Courbe à gauche

Echelle 1/5



**Darrouzet**

MCO551

Complète avec piston  
et valve anti reflux

Pédale d'aspiration

Accessoires de remplacement pour pédale d'aspiration

Echelle 1/2

Valve anti reflux - Pack 6

Piston



MCO551B































MCO551A

## Composition du set de Cause

Référence	Description
7874MF-34	Panier et couvercle perforé inox 380x205x85mm 340x200x80mm
MCO670-1	Support perforé inox 335x195mm pour container 7874MF-34
MCO12D	Micro mesureur 4,25/4,5/4,75mm tige coudée 165mm de Causse
MCO12E	Micro mesureur 5,0/6,0/7,0/8,0mm tige coudée 165mm de Vincent
MCO12H	Micro mesureur 3,5/4,0/4,5mm tige coudée 165mm de Vincent
MCO13C	Micro pince mors striés 3,0x0,6mm LU 65mm de Hartmann
MCO213-4	Gabarit à piston Ø0,4 et 0,6mm trous de 3,0 à 6,0mm 120mm
MCO27	Micro pince guillotine 2,3mm LU 65mm de Dieter
MCO4A	Micro ciseaux droits lames 3,0mm LU 65mm
MCO571	Micro punch Ø0,8mm pour Silastic 1128305 de Vincent
MCO650	Micro bistouri Ø3,0mm 90° extrémité coudée 165mm (A) de Causse
MCO651	Micro bistouri lancéolé 45° extrémité coudée 165mm (B) de Causse
MCO652	Micro bistouri Ø3,0mm 45° 165mm (C) de Causse
MCO653	Micro bistouri lancéolé 45° 1,5x2,0mm 165mm (D) de Causse
MCO654-1	Micro crochet 90° 1,2mm 165mm tranchant à droite pour tendon (E1) de Causse
MCO654-2	Micro crochet 90° 1,2mm 165mm tranchant à gauche pour tendon (E2) de Causse
MCO655	Micro curette angulée 45° Ø2,8mm 160mm (G) de Causse
MCO656	Micro désarticulateur 45° 165mm (H) de Causse
MCO657	Micro pointe courbe courbure moyenne 160mm (I) de Causse
MCO658	Micro pince à serrer le piston LU 65mm (L) de Causse
MCO660-10	Plaque lisse minérale 65x65x4mm trou Ø1,0mm de Causse
MCO660-12	Plaque lisse minérale 65x65x4mm trou Ø1,2mm de Causse
MCO660-2	Plaque lisse minérale 65x65x2mm de Causse
MCO660-8	Plaque lisse minérale 65x65x4mm trou Ø0,8mm de Causse
MCO661-10	Micro aspirateur malléable raccord luer-lock Ø1,0mm LU 90mm de Causse
MCO661-7	Micro aspirateur malléable raccord luer-lock Ø0,7mm LU 90mm de Causse
MCO662-1	Micro crochet avant courbe 0,4mm tige coudée 165mm (O1) de Causse
MCO662-2	Micro crochet arrière courbe 0,4mm tige coudée 165mm (O2) de Causse
MCO663-1	Micro crochet avant courbe 0,2mm tige coudée 165mm (P1) de Causse
MCO663-2	Micro crochet arrière courbe 0,2mm tige coudée 165mm (P2) de Causse
MCO664	Micro crochet avant 90° 0,4mm tige coudée 165mm (Q) de Causse
MCO665	Micro crochet avant 90° 0,7mm tige coudée 165mm (R) de Causse
MCO666	Micro pointe courbe mousse 165mm (S) de Causse
MCO667	Micro décolleur coudé 45° 165mm de Causse
MCO820	Presse-greffe écraseur de Martin
MCO841	Micro crochet 90° 165mm (F) de Causse

Composition du set complet sur demande



		
MCO13C	MCO213-4	MCO27
		
MCO4A	MCO571	MCO820
		
MCO650	MCO651	MCO652
		
MCO653	MCO654-1	MCO654-2
		
MCO655	MCO656	MCO657
		
MCO662-1	MCO663-1	MCO665
		
MCO657	MCO658	MCO841
		
MCO12H	MCO12E	MCO661-10
		
MCO660-12	MCO660-2	
		
MCO670-1	7874MF-34	

Photos à titre indicatif, sans échelle

MCO901

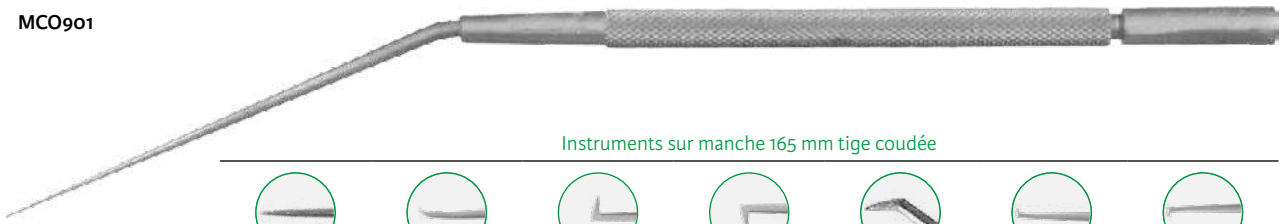

Instruments sur manche 165 mm tige coudée

Pointe fine	Ciseau burin	Crochet avant 90° 0,2mm	Crochet arrière 90° 0,2mm	Crochet avant 45° 0,9mm	Rugine avant	Rugine arrière
MCO901	MCO910M	MCO915	MCO916	MCO920	MCO917	MCO918



Instruments sur manche 165 mm tige droite

Bistouri 45° 2,8X3,5mm	Crochet mousse 90° 0,8mm	Décolleur 60° 1,3x2mm	«Queue de cochon» à droite	«Queue de cochon» à gauche	Dissecteur boule 1mm
MCO932	MCO950	MCO904	MCO905	MCO906	MCO924



Décolleur double

	<b>MCO925</b> 180mm 3mm			<b>MCO929</b> 170mm contre courbé	
	<b>MCO926</b> 180mm plat 1,7 / 5mm			<b>MCO951</b> 170mm courbe	
	<b>MCO928</b> 175mm courbe 0,9mm				

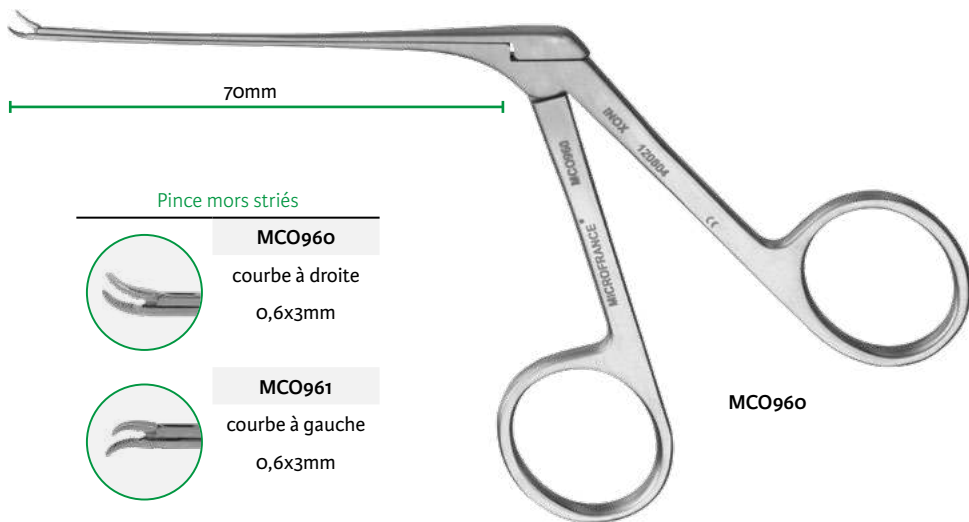

Pince mors striés

	<b>MCO960</b> courbe à droite 0,6x3mm
	<b>MCO961</b> courbe à gauche 0,6x3mm

MCO960



Micro décolleur «canne de golf» coudé 165mm



3722001 0,75mm à gauche

3722002 0,75mm à droite

## Instruments de Guilford-Wright



Micro crochet 0,5mm 165mm



**3722020** 45°

**3722021** 90°

## Instrument de Shea



Micro crochet 90° 165mm



**3722142** 1mm



Micro bistouri 165mm

A	3722031	45°	Ø 2mm
---	---------	-----	-------

Micro crochet 90° 165mm

B	3722035	0,6mm	
---	---------	-------	--

Micro crochet 165mm

C	3724287	45°	0,33mm
---	---------	-----	--------

Micro crochet tranchant tige coudée 160mm

D	3724291	90°	0,5mm
---	---------	-----	-------

Instrument de Jordan



Micro bistouri lancéolé 165mm



3724293

45°

2x3mm

3724293

### Micro rugine- Micro crochet



MCO9-1

Rugine 90°

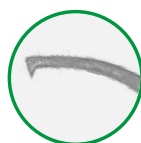

MCO804

Crochet 90° 0,7mm

### Micro décolleur double

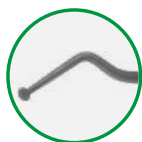

MCO929

contre coudé

Marquet



MCO240

coudé  
«canne de golf»  
Chobaut



## Manche aspirateur à soupape - Aspirateur coudé

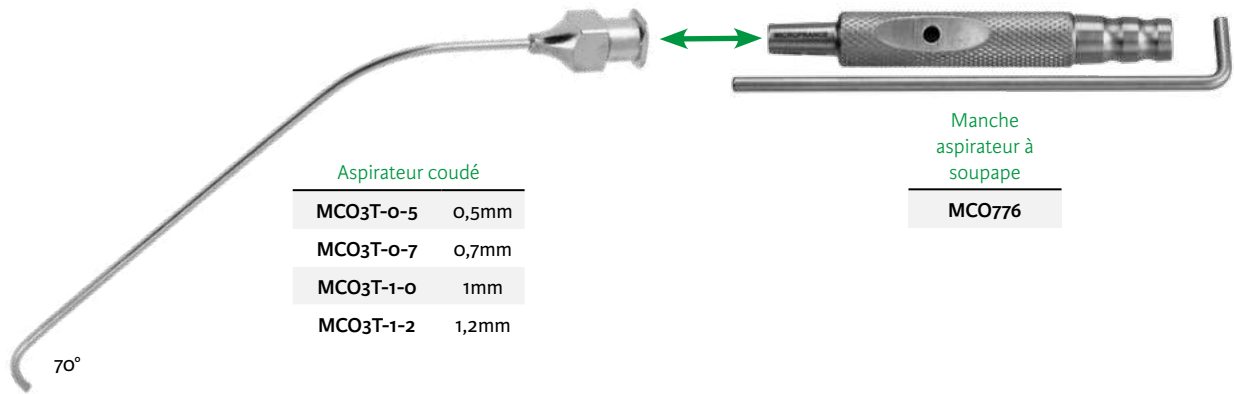

Aspirateur coudé

MCO3T-o-5	0,5mm
MCO3T-o-7	0,7mm
MCO3T-1-o	1mm
MCO3T-1-2	1,2mm

Manche aspirateur à soupape

MCO776

70°

## Micro pinces



Micro pince mors striés

MCO35

90°



Micro pince mors curettes

MCO36

90° Ø0,8mm

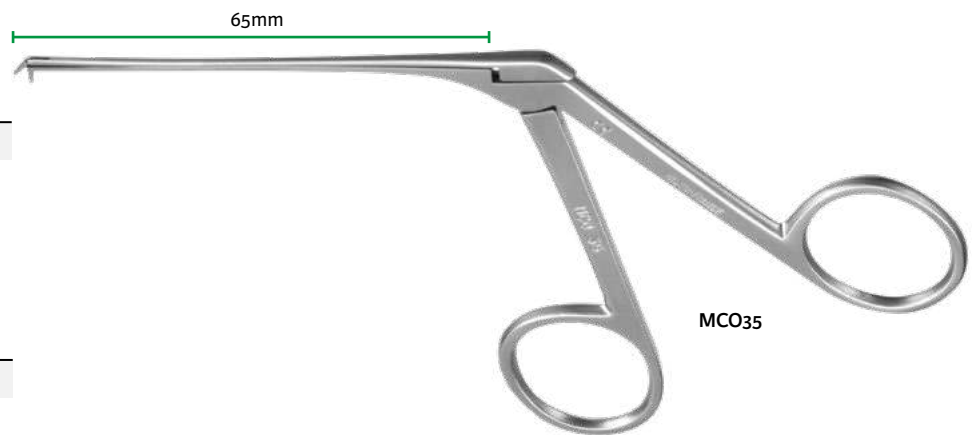

MCO35

## Container - Support

Container

7874MF-22

220x100x40mm

Echelle 1/4

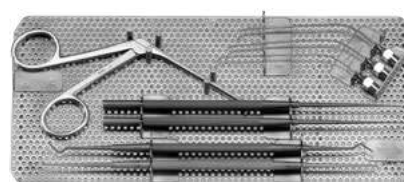
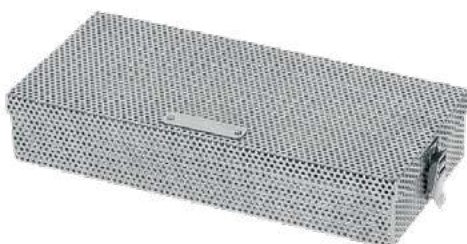

Support

MCO866

215x95mm

Echelle 1/4



**Bistouri lancéolé**

**Curette double**

**Décolleur aspirateur**

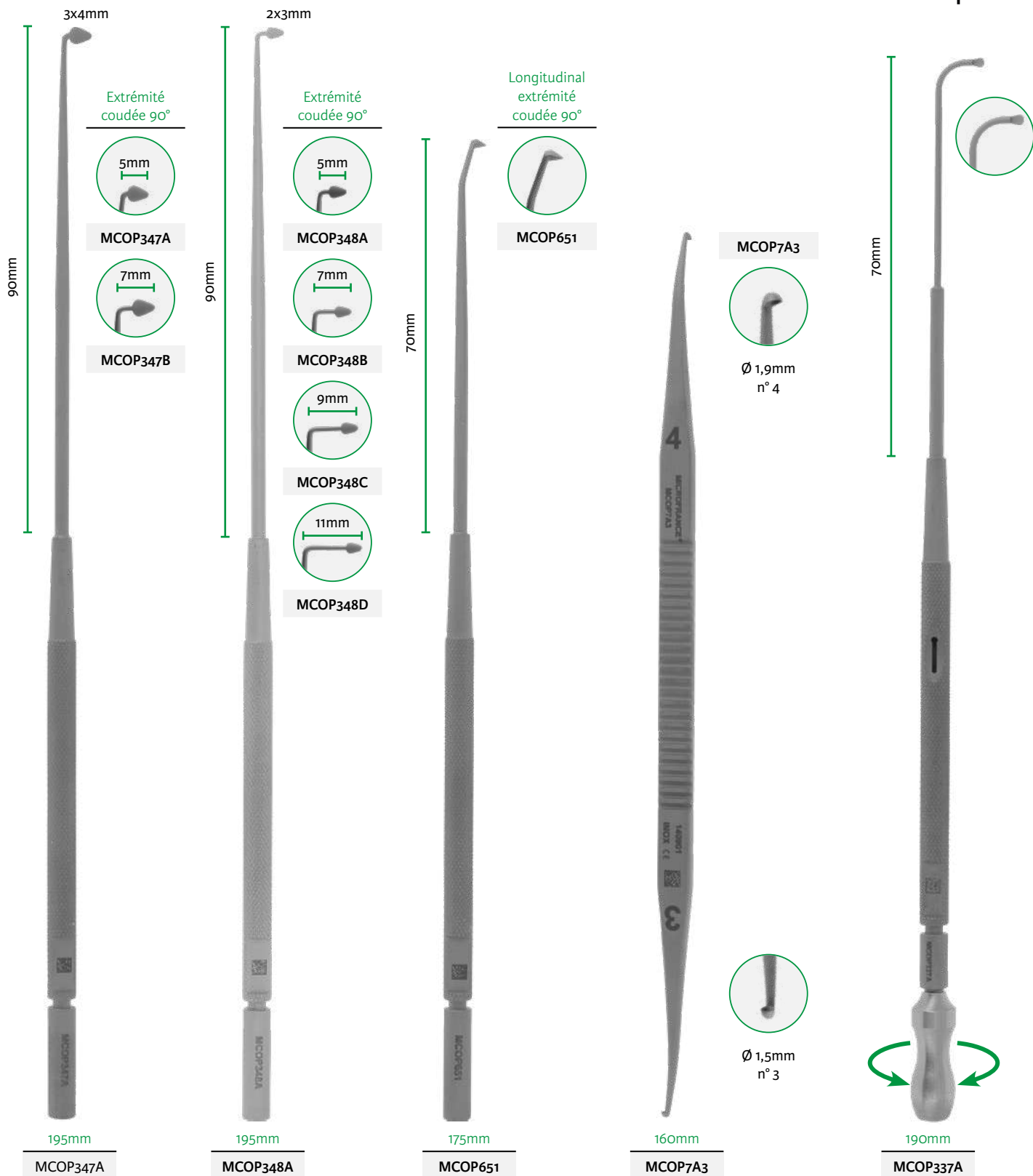

Support seul

MCOP821-1

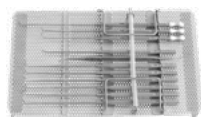

Container  
25x15x6cm

7874MF-25



**Aspirateur à soupape**

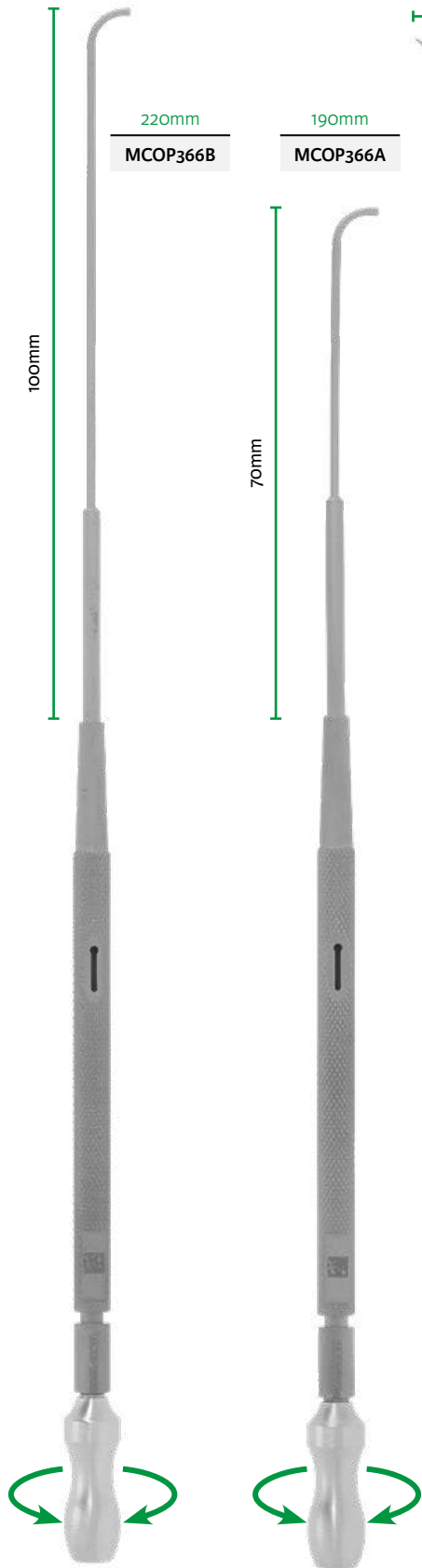

**Micro pince mors alligator**

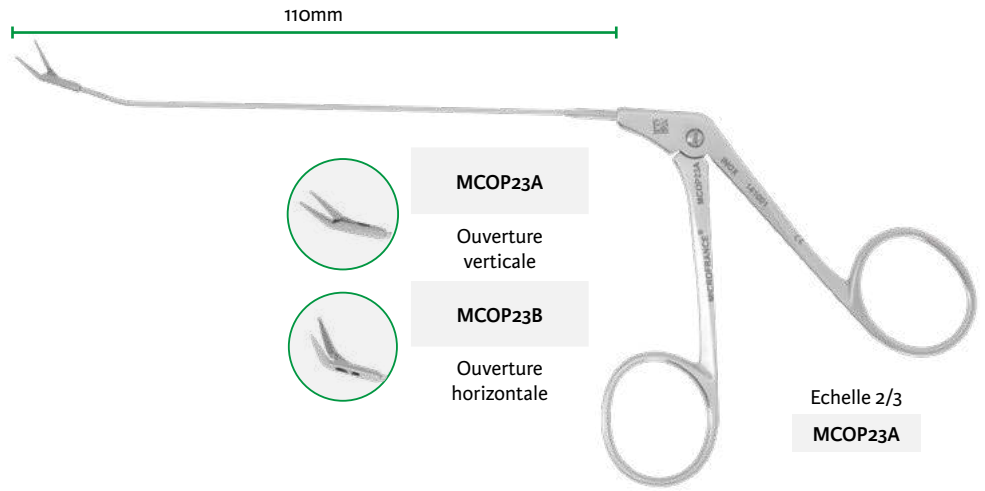

**Micro pince à serrer le piston métallique**

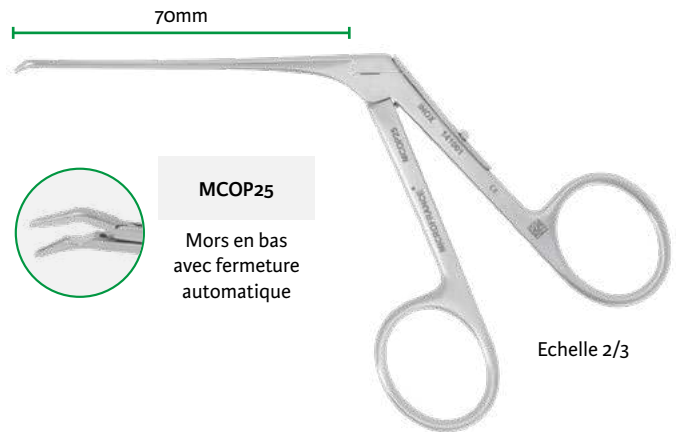

**Presse-greffe écraseur**

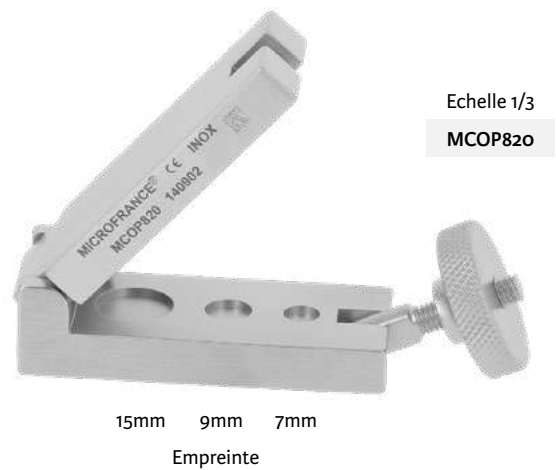

Echelle 2/3  
"LU" Longueur utile

**Micro aspirateur raccord luer-lock**



**Fraysse**

115mm

LU 115mm		LU 150mm	
MCO367F10	1mm	MCO368F20	2mm
MCO367F12	1,2mm	MCO368F25	2,5mm
MCO367F15	1,5mm		
MCO367F20	2mm		

MCO367F10



**Zimmermann**

100mm

MCO354	1,2mm
--------	-------

MCO354

**Micro aspirateur à soupape**



**Charachon**

140mm

Bout rétreint et crépine

LU 110mm		LU 140mm	
MCO352E20	2mm	MCO352N20	2mm
MCO352E25	2,5mm	MCO352N25	2,5mm

MCO352N25



**Modèle Lille**

120mm

Bout rétreint à oeillet

MCO770L15	1,5mm	MCO770L30	3mm
MCO770L20	2mm	MCO770L35	3,5mm
MCO770L25	2,5mm	MCO770L40	4mm

MCO770L30

**Micro aspirateur irrigateur à soupape**



**Brackman**

90mm

MCO352-20	2mm
MCO352-25	2,5mm
MCO352-30	3mm

Bout rétreint et crépine

MCO352-25

Micro ciseaux, micro pinces

Sterkers

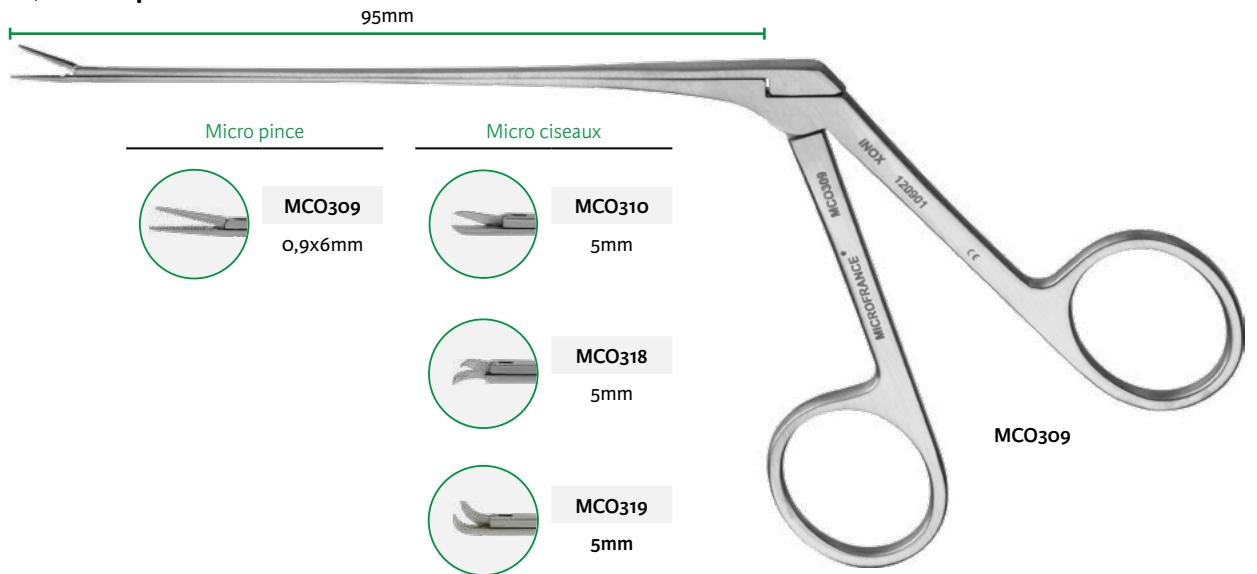

Ecarteurs autostatiques

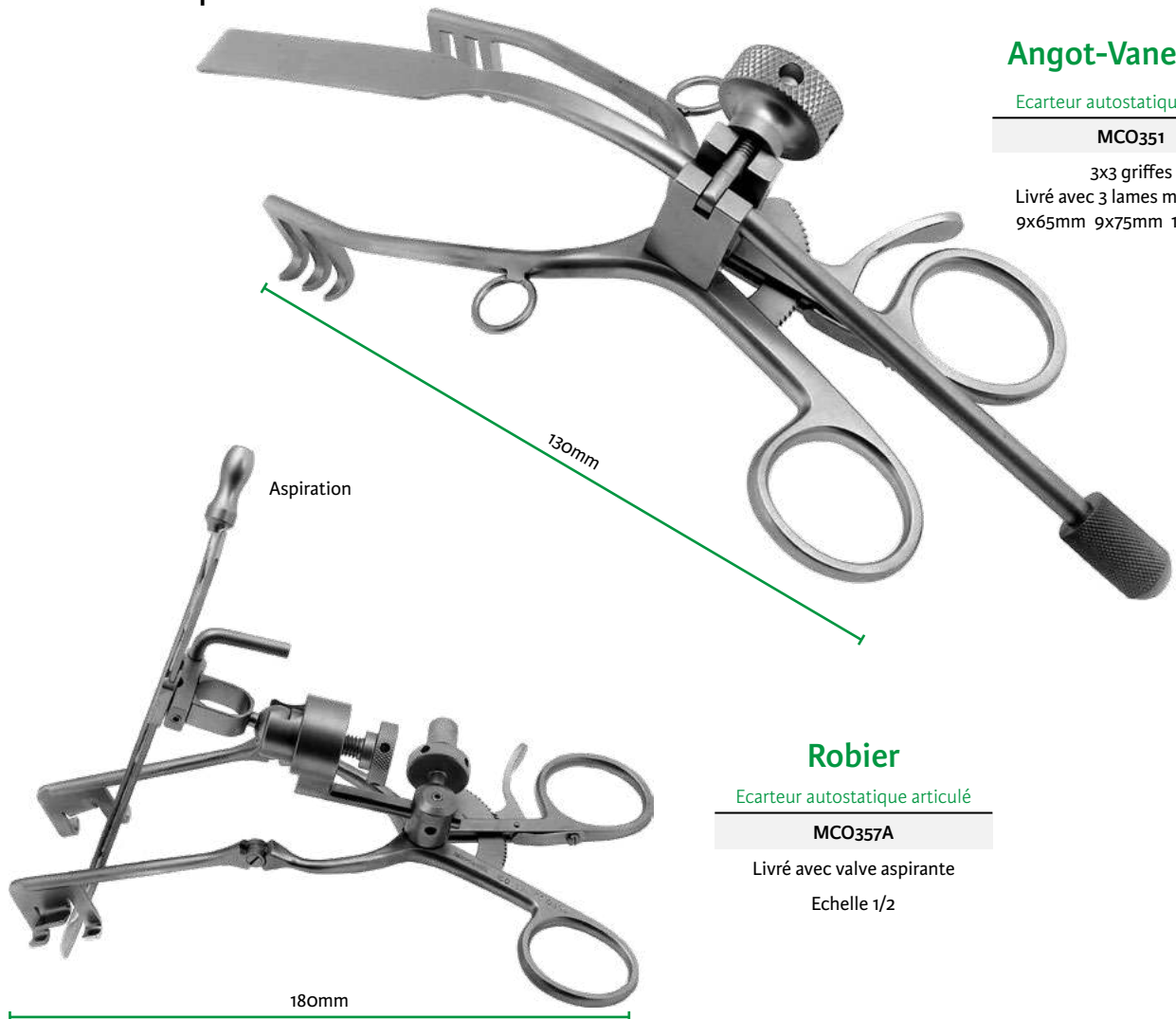

Angot-Vaneecloo

Ecarteur autostatique courbe

MCO351

3x3 griffes

Livré avec 3 lames malléables  
9x65mm 9x75mm 12x55mm

Robier

Ecarteur autostatique articulé

MCO357A

Livré avec valve aspirante

Echelle 1/2

Echelle 2/3

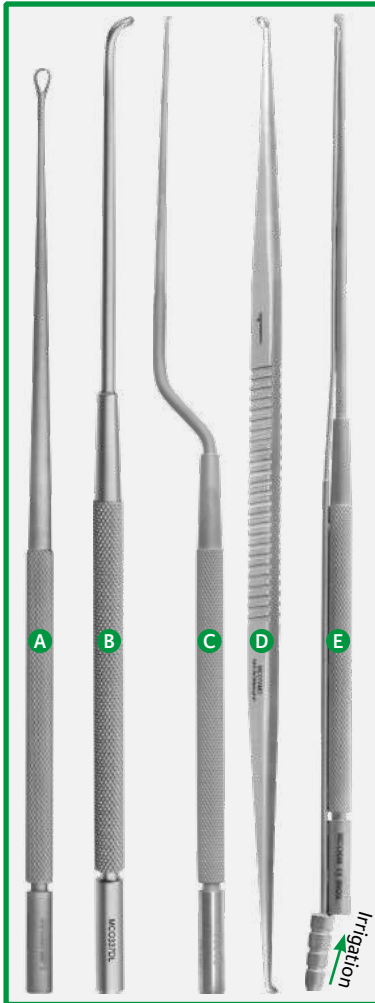

Micro instruments sur manche

Sterkers

Bistouri falciforme 180mm		MCO301	7mm
		MCO302	90° 2mm
Crochet 180mm		MCO303	90° 1,2mm
		MCO304	90° 0,8mm
Curette fenêtrée 180mm		MCO320 <b>A</b>	3mm
		MCO321	4mm
		MCO322	6mm

Décolleur et rugine

Décolleur 180mm Dubreuil		MCO337DL <b>B</b>	coudé à gauche
		MCO337DR	coudé à droite
Rugine 175mm Gentine		MCO224G	45° 7x4mm
Curette fenêtrée 195mm Klap		MCO333	courbe 1,5x7mm

Micro instruments tige baïonnette

Crochet 190mm Magnan		MCO341	2mm à gauche
		MCO340 <b>C</b>	2mm à droite
Pointe mousse 190mm Bruzzo		MCO342	droite
		MCO343	courbe

Micro instruments de Mom

Mom

Curette double angulée 190mm		MCO7AMO <b>D</b>	2,2 / 2,5mm n° 1/2
Bistouri 190mm		MCO6M <b>E</b>	2x2,5mm
Bistouri falciforme 190mm		MCO10MO	5mm
Pointe courbe 190mm		MCO221MO	grande courbure
Dissecteur boule 190mm		MCO330MO	2mm 90°

Micro instruments sur manche





Selesnick

Echelle 2/3

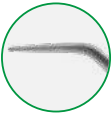
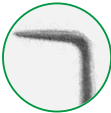

190mm





**Crochet**

					
MCOS14	MCOS15	MCOS16	MCOS17	MCOS25	MCOS26
45° 3mm	90° 2mm	90° 2,8mm	1mm MCOS18 2mm MCOS19 3mm	Ø 1mm Droite	Ø 1mm Angulée

**Bistouri 45°**

**Curette**

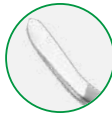
**Décolleur**

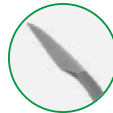
						
MCOS20	MCOS21	MCOS22	MCOS23	MCOS30	MCOS31	MCOS32
14 x1,5mm	3mm	5x1mm	7x2mm	A gauche	A droite	5mm



**Bistouri falciforme**

Pince mors curettes, ciseaux



125mm

Echelle 2/3

**Pince mors curettes**

	
MCOS27	MCOS29
1mm	3mm

**Ciseaux lames 7mm**

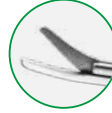
			
MCOS33	MCOS34	MCOS35	MCOS36
Droit	Coudés dessus	Courbes à gauche	Courbes à droite

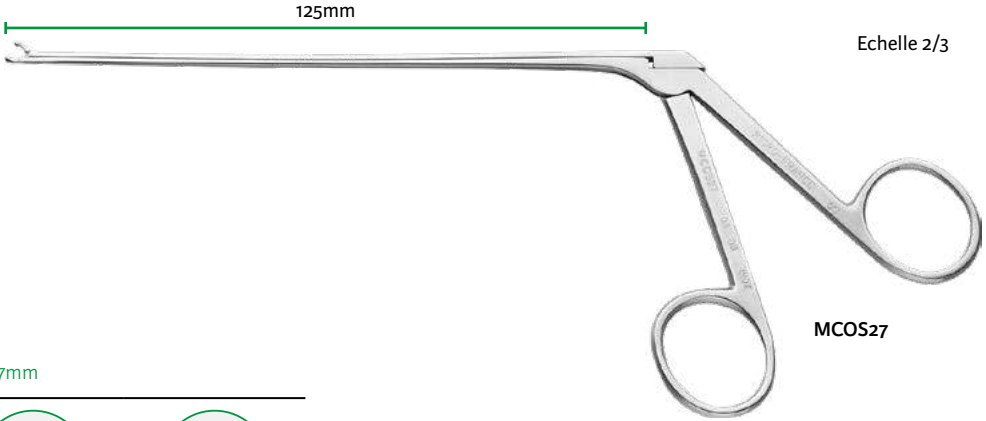

**Ecarteur autostatique courbe**

**Angot-Vaneecloo**

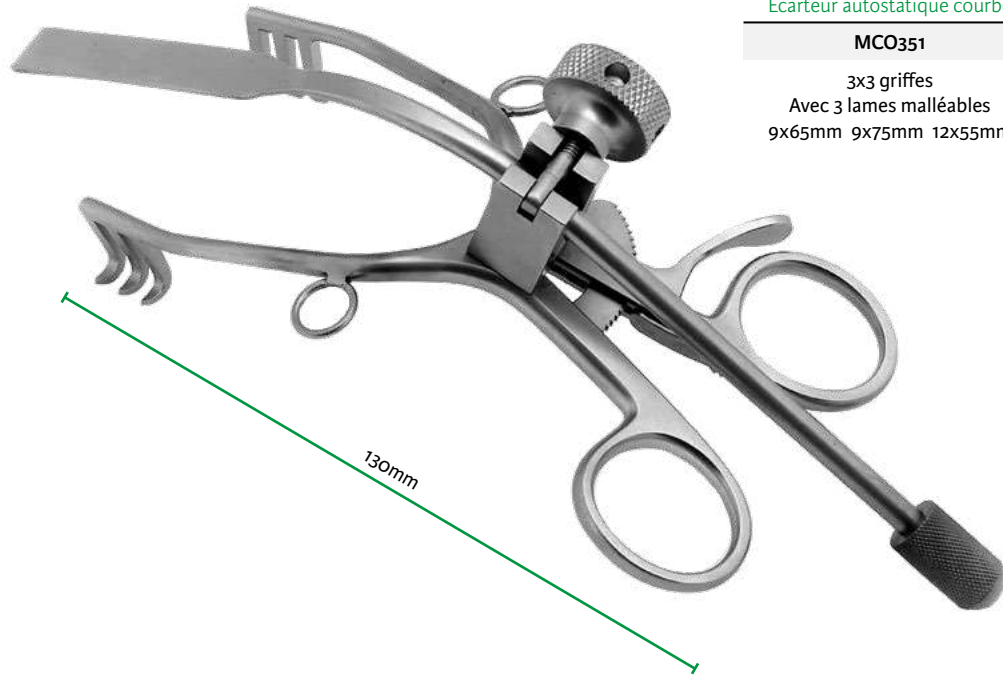

Ecarteur autostatique courbe

**MCO351**

3x3 griffes  
Avec 3 lames malléables  
9x65mm 9x75mm 12x55mm

**Pince bipolaire**

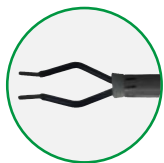
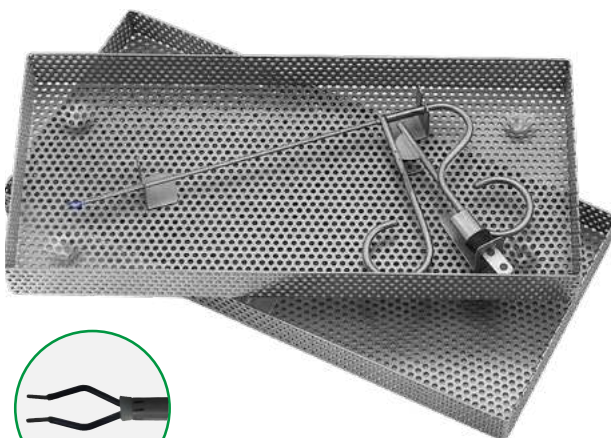

Page 36

Pince bipolaire

**MCO291**

Longueur utile 120mm  
Livré avec panier et couvercle  
perforé inox  
Echelle 1/3

**Panier pour instruments sur manche**



Panier perforé plastique

**3717022**

210x123x36mm  
pour 16 instruments sur manche  
Echelle 1/5

## Cupule



7876-60<sup>(D)\*</sup>

### Cupule

7876-60 <sup>(D)*</sup>	60mm
7876-80 <sup>(D)*</sup>	80mm
7876-100 <sup>(D)*</sup>	100mm
7876-120 <sup>(D)*</sup>	120mm
7876-160 <sup>(D)*</sup>	160mm

## Plateau inox



7872-24<sup>(D)\*</sup>  
Echelle 1/2

### Plateau inox

7872-24 <sup>(D)*</sup>	240x180mm
-------------------------	-----------

<sup>(D)</sup> Distribué par Integra MicroFrance SAS (France) - Voir tableau d'équivalence annexe pour la référence du fabricant correspondante.

\* Veuillez vérifier auprès de votre représentant commercial la disponibilité de ce produit dans votre pays.



Echelle 1/5

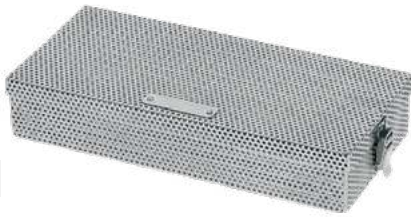

**7874MF-22**

240x105x45mm  
220x100x40mm

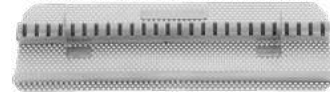

**MCO865-1**

pour 26 fraises

Echelle 1/5

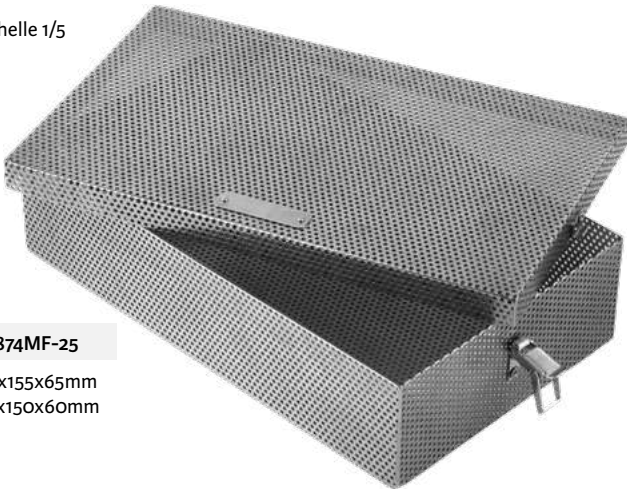

**7874MF-25**

270x155x65mm  
250x150x60mm

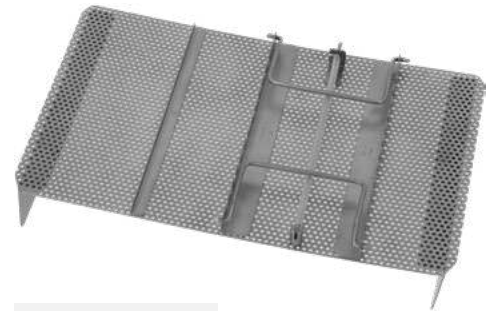

**MCO821-1**

12 micro instruments

Echelle 1/5

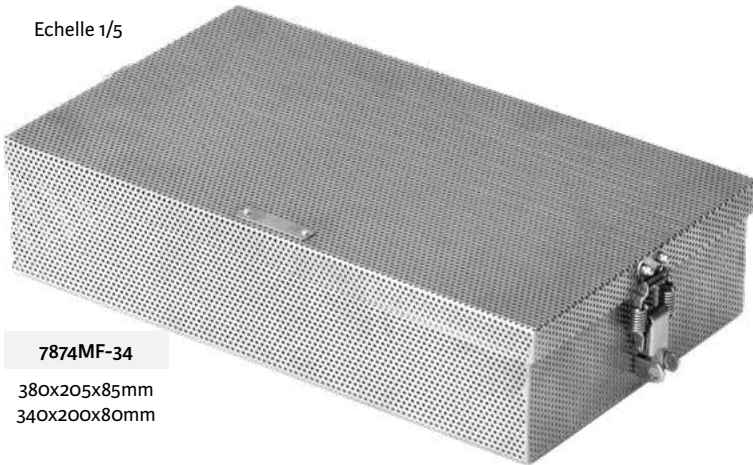

**7874MF-34**

380x205x85mm  
340x200x80mm

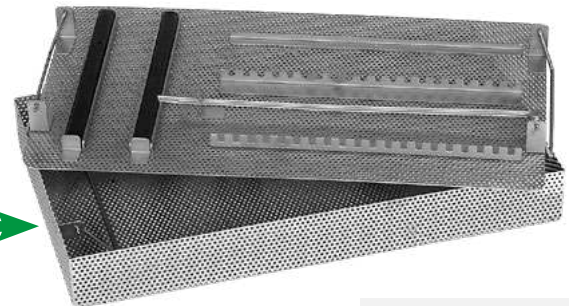

**MCO824-1**

Set micro instruments

Echelle 1/5

**7874MF-40**

440x205x95mm - 400x200x90mm

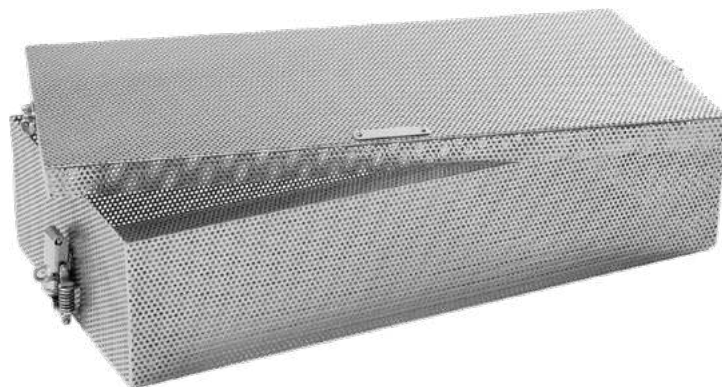

Echelle 1/4

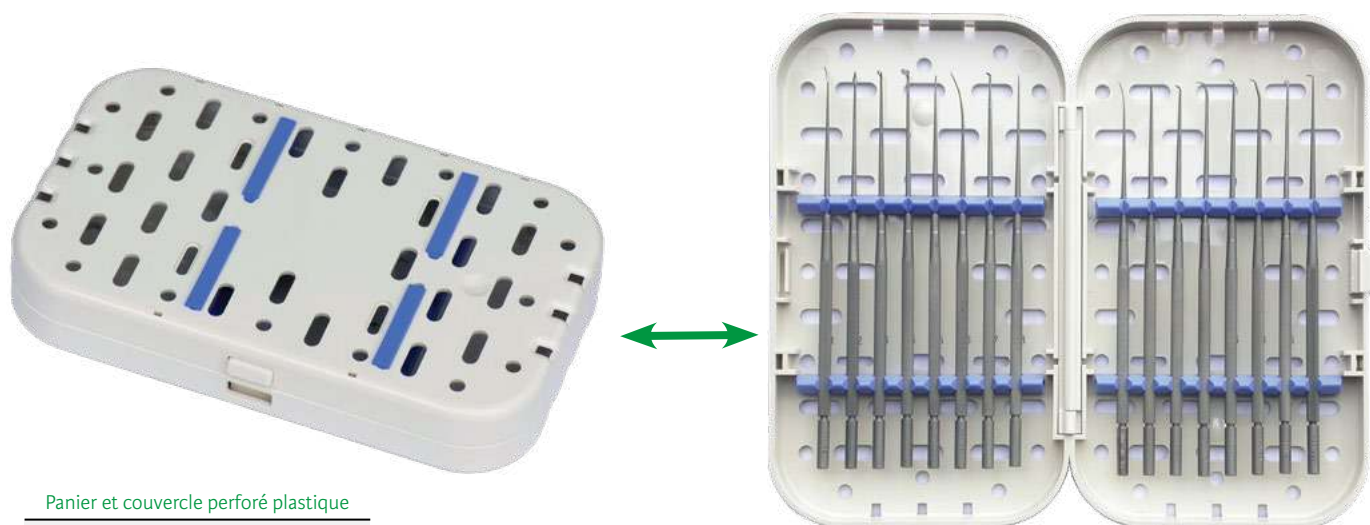

Panier et couvercle perforé plastique

3717022

210x123x36mm

pour 16 instruments sur manche



Panier perforé aluminium

3717025

248x221x45mm

pour 32 instruments sur manche





## **Index numérique**

**O**

O-28	17
O-28-1	17
O-28-2	17
O-28-3	18
O-28-4	18
O-28-7	19
O-28-8	17

**1**

1003IG(D)	7
1003LI(D)	7
1004IG(D)	7
1005I(D)	7

**3**

3714027	16
3714028	16
3717022	75, 78
3717025	78
3722001	63
3722002	63
3722020	64
3722021	64
3722031	65
3722035	65
3722142	64
3722150	5
3722151	5
3724059	14
3724287	65
3724291	65
3724293	66

**7**

702T	35
703T	35
704T	35
714T	35
7718	3
7719-2	2
7721-1	5
7725	5
7725P1	5
7725P2	5
7725P3	5
7726MF	11
7727	11
7728	11
7731	2
7732-1	11
7733	11
7734	11
7764	24
7766	21
7768	15

7768-1	15
7779MF-1	12
7779MF-2	12
7779MF-3	12
7779MF-5CC	12
7781	20
7782-1-2	16
7787-10	14
7831A-12	30
7831A-15	32
7833A-12	30
7833A-15	32
7866-13	39
7867-1	36
7867-2	36
7867-3	36
7867-4	36
7872-24(D)	76
7874MF-22	68, 77
7874MF-25	69, 77
7874MF-34	60, 61, 77
7874MF-40	77
7875(D)	4
7876-60(D)	76
7876-80(D)	76
7876-100(D)	76
7876-120(D)	76
7876-160(D)	76
7885	3
7885A	3
7886	3
7888	3
7897	9
7898	9
7899	9

**8**

8812-1	8
8812-2	8
8812-3	8
8812-4	8
8812-5	8
8814T1	8
8814T2	8
8814T3	8
8814T4	8
8814T5	8

**9**

9912-7(D)	8
9912-8(D)	8
9912-9(D)	8
9913-1(D)	8
9913-2(D)	8
9913-3(D)	8
9913-4(D)	8
9913-5(D)	8
9913-6(D)	8

**C**

CEV984	10
CEV985	10
CP16	26
CP16-1	26
CP17	15
CP17-1	15
CP17-2	15
CP17-3	15
CP21-3	16
CP21A-3	16
CP37	30
CP85AL	59
CP85AR	59
CP85L	59
CP85R	59
CP300	22
CP302-2	50
CP302-3	50
CP302-4	50
CP302-5	50
CP302-6	50
CP302-8	50
CP330-3-0	40
CP330-4-0	40
CP332	30
CP335	16
CP351-2	28
CP351-3	28
CP351-6	28
CP351-7	28
CP352	29
CP352-1	29
CP352-2	29
CP352-3	29
CP353	26
CP354	26
CP354A	26
CP356	26
CP358	26
CP358A	26
CP363	27
CP380	25
CP380-1	25
CP380-2	25
CP380-3	25
CP380-5	25
CP390-1	34
CP390-2	34
CP390-8	34
CP391E	34, 54
CP391M	34, 54
CP391V	34, 54
CP392-1R	33
CP392-2R	33
CP392-8R	33
CP392BI	33
CP392BS	33
CP393-2	33, 54
CP393-3	33, 54

CP393-4	33, 54
CP400	32
CP400-1	30
CP406	30
CP407	32
CP414	30
CP415	32
CP604	31
CP604-15	31
CP604BR	33
CP604M	34
CP605	31
CP605-15	31
CP605BR	33
CP605M	34
CP606	31
CP606-15	31
CP606A	31
CP609	16
CP611	13
CP625	13
CP626	13
CP627	13
CP628	15
CP637	27
CP801-7	23
CP801-10	23
CP821	7
CP821B	6
CP821C	6
CP821D	6
CP821E	6
CP822-10	15
CP822-12	15
CP822-14	15
CP823-5	23
CP824-5	23
CP825	14
CP907	22
CP919	26
CP919A	26
CP922	27
CP922A	27
CP922B	27
CP931	28
CP931-1	28
CP933-14	32
CP934	32
CP934-1	32
CP938-1	30
CP941	15
CP985	13
CP988-15	32
CP1107	35

**M**

M832	31
M833	31
MCEN23-2-5	41

<sup>(D)</sup> Distribué par Integra MicroFrance SAS (France) - Voir tableau d'équivalence annexe pour la référence du fabricant correspondante

MCEN23-3-0.....	41	MCO13C .....	44, 60, 61	MCO226 .....	52	MCO367F12.....	71
MCEN770J30.....	40	MCO13D .....	44	MCO226A.....	52	MCO367F15.....	71
MCEN770J40.....	40	MCO13E.....	44	MCO226B.....	52	MCO367F20.....	71
MCL359 .....	20	MCO17 .....	44	MCO226C .....	52	MCO368F20.....	71
MCO1B.....	41	MCO21 .....	45	MCO233 .....	9	MCO368F25.....	71
MCO2 .....	48	MCO21A .....	45	MCO237.....	9	MCO551.....	59
MCO3Po5.....	43	MCO21B .....	45	MCO240.....	49, 67	MCO551A .....	59
MCO3Po7.....	43	MCO21C .....	45	MCO250.....	57	MCO551B .....	59
MCO3P10 .....	43	MCO21D.....	45	MCO251.....	57	MCO571.....	56, 60, 61
MCO3P12.....	43	MCO21G.....	45	MCO255 .....	57	MCO650.....	48, 60, 61
MCO3P15.....	43	MCO21H.....	45	MCO270.....	46	MCO651.....	48, 60, 61
MCO3P18.....	43	MCO21I.....	45	MCO271.....	46	MCO651F.....	48
MCO3P20.....	43	MCO22 .....	44	MCO272 .....	46	MCO652.....	48, 60, 61
MCO3P24 .....	43	MCO23 .....	44	MCO290.....	54	MCO653 .....	48, 60, 61
MCO3T-0-5.....	68	MCO23A.....	44	MCO291.....	54, 75	MCO654-1.....	52, 60, 61
MCO3T-0-7.....	68	MCO23B .....	44	MCO301.....	73	MCO654-2 .....	52, 60, 61
MCO3T-1-0 .....	68	MCO25 .....	47	MCO302.....	73	MCO655 .....	50, 60, 61
MCO3T-1-2.....	68	MCO25H.....	47	MCO303 .....	73	MCO656.....	53, 60, 61
MCO4 .....	45	MCO26 .....	47	MCO304.....	73	MCO657 .....	51, 60, 61
MCO4A.....	45, 60, 61	MCO27 .....	46, 60, 61	MCO305.....	13	MCO658.....	47, 60, 61
MCO4B.....	45	MCO31.....	51	MCO309.....	72	MCO660-2.....	58, 60, 61
MCO4C.....	45	MCO32 .....	51	MCO310.....	72	MCO660-8.....	58, 60
MCO4D .....	45	MCO34 .....	55	MCO311-1-0 .....	41	MCO660-10.....	58, 60
MCO4E .....	45	MCO35 .....	68	MCO311-1-2.....	41	MCO660-12.....	58, 60, 61
MCO5 .....	48	MCO36 .....	68	MCO311-1-5.....	41	MCO661-7.....	43, 60
MCO5A-1-0.....	48	MCO37.....	49	MCO311-1-8.....	41	MCO661-10.....	43, 60, 61
MCO5A-1-5 .....	48	MCO37-1.....	49	MCO311-2-0 .....	41	MCO662-1.....	52, 60, 61
MCO5A-2-0 .....	48	MCO37D.....	49	MCO311-2-5 .....	41	MCO662-2 .....	52, 60
MCO5A-2-5.....	48	MCO37G.....	49	MCO311-3-0.....	41	MCO663-1.....	52, 60, 61
MCO5B.....	48	MCO38 .....	55	MCO311-3-5 .....	41	MCO663-2 .....	52, 60
MCO5C.....	48	MCO201-2-5.....	40	MCO311-4-0.....	41	MCO664.....	52, 60
MCO5D.....	48	MCO201-3-0.....	40	MCO312.....	48	MCO665.....	52, 60, 61
MCO5E .....	48	MCO204C.....	48	MCO313.....	48	MCO666.....	51, 60
MCO6 .....	48	MCO205.....	52	MCO318.....	72	MCO667 .....	49, 60
MCO6A.....	52	MCO205A.....	52	MCO319.....	72	MCO670-1.....	60, 61
MCO6B.....	52	MCO205B.....	52	MCO320.....	73	MCO770-1-5 .....	40
MCO6C.....	48	MCO205C.....	52	MCO321.....	73	MCO770-2-0 .....	40
MCO6M.....	73	MCO205D.....	52	MCO322 .....	73	MCO770-2-5.....	40
MCO7-1 .....	50	MCO207-1-5 .....	50	MCO330MO.....	73	MCO770-3-0 .....	40
MCO7-3 .....	50	MCO207-2-0 .....	50	MCO333.....	73	MCO770-3-5 .....	40
MCO7A-1.....	50	MCO209.....	53	MCO337DL.....	73	MCO770-4-0 .....	40
MCO7A-3 .....	50	MCO210.....	49	MCO337DR.....	73	MCO770L15 .....	71
MCO7A-5 .....	50	MCO213-4 .....	58, 60, 61	MCO340.....	73	MCO770L20.....	71
MCO7A6.....	50	MCO213-6 .....	58	MCO341.....	73	MCO770L25.....	71
MCO7AMO .....	73	MCO214-13-10.....	23	MCO342 .....	73	MCO770L30.....	71
MCO8 .....	49	MCO214-13-20.....	23	MCO343 .....	73	MCO770L35 .....	71
MCO8B.....	49	MCO214-13-40.....	23	MCO351.....	72, 75	MCO770L40 .....	71
MCO8BM .....	54	MCO214-13-60.....	23	MCO352-20 .....	71	MCO771-2-5 .....	40
MCO9 .....	53	MCO214-13-80.....	23	MCO352-25.....	71	MCO771-3-0 .....	40
MCO9-1.....	53, 67	MCO215.....	48	MCO352-30 .....	71	MCO771-4-0 .....	40
MCO10 .....	48	MCO216-3-5 .....	49	MCO352E20.....	71	MCO772 .....	41
MCO10B .....	48	MCO218-4 .....	58	MCO352E25 .....	71	MCO773.....	42
MCO10M.....	48	MCO218-6.....	58	MCO352N20.....	71	MCO774-0-4.....	42
MCO10MO.....	73	MCO218-8.....	58	MCO352N25 .....	71	MCO774-0-5.....	42
MCO12B .....	55	MCO221.....	51	MCO354 .....	71	MCO774-0-6.....	42
MCO12D .....	55, 60	MCO221A.....	51	MCO357A.....	72	MCO774D8.....	42
MCO12E.....	55, 60, 61	MCO221MO .....	73	MCO366F10 .....	43	MCO775-1 .....	41
MCO12H.....	55, 60, 61	MCO222 .....	46	MCO366F12 .....	43	MCO776 .....	41, 68
MCO12R .....	55	MCO224-2-0 .....	49	MCO366F15 .....	43	MCO781.....	5
MCO13A.....	44	MCO224A-2-0.....	49	MCO366F20.....	43	MCO782L.....	47
MCO13B.....	44	MCO224G .....	73	MCO367F10 .....	71	MCO782R.....	47

(D) Distribué par Integra MicroFrance SAS (France) - Voir tableau d'équivalence annexe pour la référence du fabricant correspondante

MCO800	51	MCO980	10
MCO801	51	MCO981	10
MCO802	51	MCO981D	10
MCO803	13	MCO983-4	10
MCO804	53, 67	MCO985	56
MCO805	2	MCO988	14
MCO805A	2	MCO989	54
MCO806	52	MCO995	21
MCO806A	52	MCO997	56
MCO806B	52	MCOP7A3	69
MCO807	2, 52	MCOP23A	70
MCO813	51	MCOP23B	70
MCO817	49	MCOP25	70
MCO818	50	MCOP337A	69
MCO819	57	MCOP347A	69
MCO820	57, 60, 61	MCOP347B	69
MCO821-1	69, 77	MCOP348A	69
MCO823	59	MCOP348B	69
MCO824-1	77	MCOP348C	69
MCO830	55	MCOP348D	69
MCO832A	52	MCOP366A	70
MCO832B	52	MCOP366B	70
MCO832C	52	MCOP651	69
MCO832D	52	MCOP820	70
MCO841	52, 60, 61	MCOR20	55
MCO844	56	MCOR25	55
MCO865-1	77	MCOR30	55
MCO866	68	MCOR35	55
MCO890	42	MCOR40	55
MCO890-1-04	42	MCOR45	55
MCO890-1-08	42	MCOR50	55
MCO890-1-12	42	MCOR55	55
MCO890-1-15	42	MCOR60	55
MCO890-1-20	42	MCOR65	55
MCO901	51, 62	MCOR70	55
MCO904	62	MCOR75	55
MCO905	49, 62	MCOR80	55
MCO906	49, 62	MCOS14	74
MCO910M	62	MCOS15	74
MCO915	52, 62	MCOS16	74
MCO916	52, 62	MCOS17	74
MCO917	62	MCOS18	74
MCO918	62	MCOS19	74
MCO920	52, 62	MCOS20	74
MCO924	62	MCOS21	74
MCO925	62	MCOS22	74
MCO926	62	MCOS23	74
MCO928	62	MCOS25	74
MCO929	49, 62, 67	MCOS26	74
MCO932	62	MCOS27	74
MCO950	2, 52, 62	MCOS29	74
MCO951	49, 62	MCOS30	74
MCO960	44, 62	MCOS31	74
MCO961	44, 62	MCOS32	74
MCO970	53	MCOS33	74
MCO971T	53	MCOS34	74
MCO973T	53	MCOS35	74
MCO978	10	MCOS36	74
MCO978S	10		
MCO979	14		

**N**

N480G	45
-------	----

**P**

P761-7	36
P761-8	36
P762-2	37
P762-4	37
P763	38
P764-1	37
P764-3	37
P764-5	37
P764-7	37
P764-11	37
P765-14	38
P765-16	38
P769	38

**S**

SM63(D)	6
SM64(D)	6
SM65(D)	6



**Tableau d'équivalence  
à titre informatif**

Integra MicroFrance® référence produit	Référence fabricant équivalente
1003IG	M3IG
1003LI	M3LI
1004IG	M4IG
1005I	M5I
7872-24	1224
7875	1724
7876-100	310
7876-120	312
7876-160	316
7876-60	306
7876-80	308
9912-7	6617-7
9912-8	6617-8
9912-9	6617-9
9913-1	6611
9913-2	6612
9913-3	6613
9913-4	6614
9913-5	6615
9913-6	6616
SM63	SM63
SM64	SM64
SM65	SM65





Integra MicroFrance SAS (France)  
Le Pavillon ■ 03160 Saint Aubin le Monial ■ France



Swann Morton Ltd  
Penn Works ■ Owlerton Green ■ Sheffield  
South Yorkshire S6 2BJ ■ Royaume Uni



Emergo Europe  
Prinsessegracht 20 ■ 2514 AP The Hague  
Pays-Bas

Fabricants avec produits du catalogue uniquement de classe I



Agencinox  
Zone Industrielle  
89110 Aillant sur Tholon ■ France



Concorde Import Export  
B.P. 37  
92300 Levallois-Perret ■ France

#### Informations supplémentaires pour les clients Europe, Moyen-Orient, Afrique :

**Attention :** la loi restreint la vente de ces appareils à des médecins ou suite à leur prescription.

Tous les dispositifs médicaux mentionnés dans ce document sont marqués CE conformément aux lois européennes applicables, sauf mention spécifique "PAS DE MARQUAGE CE".

Les produits mentionnés dans ce document ne sont pas inscrits à la Liste des Produits et Prestations Remboursables (LPPR) mentionnée à l'article L165-1 du code de la sécurité sociale et ne sont pas éligibles au remboursement par l'Assurance Maladie.

Tous les textes et diagrammes contenus dans ce catalogue sont à considérer comme des notes d'orientations et sont à but illustratif seulement. Aucune information contenue dans ce catalogue n'a pour but de se substituer au mode d'emploi présent dans chaque emballage des produits Integra. Veuillez toujours vous référer au mode d'emploi approprié pour les instructions cliniques complètes. Pour des informations supplémentaires techniques et cliniques sur les produits Integra, veuillez contacter votre spécialiste Integra. Lire attentivement la notice d'instructions du produit.

La disponibilité de ces produits peut varier d'un pays ou d'une région à l'autre du fait de procédures d'enregistrement réglementaires ou de conditions de vente locales spécifiques.

Les produits identifiés par le symbole (D) sont distribués par Integra MicroFrance SAS (France).

Produits de classe I, Im, IIa, IIb. Pour plus d'informations sur la classe des produits, veuillez contacter le Service Client Integra.

Consultez les étiquettes et les notices des produits pour connaître les indications, les contre-indications, les dangers, les avertissements et les précautions à prendre.

Date de dernière révision: 03/2023

## Pour plus d'informations, veuillez contacter le service client :

### Europe, Moyen-Orient, Afrique

International : +33 (0) 4 37 47 59 50 ■ +33 (0) 4 37 47 59 25 (Fax) ■ [csemea@integralife.com](mailto:csemea@integralife.com)  
France : +33 (0) 4 37 47 59 10 ■ +33 (0) 4 37 47 59 29 (Fax) ■ [custservfrance@integralife.com](mailto:custservfrance@integralife.com)  
Belgique & Luxembourg : +32 (0) 2 257 4130 ■ +32 (0) 2 253 2466 (Fax) ■ [custsvcbenelux@integralife.com](mailto:custsvcbenelux@integralife.com)  
Royaume-Uni : +44 (0) 1264 312 725 ■ +44 (0) 1264 312 821 (Fax) ■ [custsvcs.uk@integralife.com](mailto:custsvcs.uk@integralife.com)  
Pays-Bas : +31 (0) 852 083 167 ■ +31 (0) 207 093 627 (Fax) ■ [custsvcnetherlands@integralife.com](mailto:custsvcnetherlands@integralife.com)  
Italie : +39 (0) 2 577 8921 ■ +39 (0) 2 575 113 71 (Fax) ■ [custsvcityal@integralife.com](mailto:custsvcityal@integralife.com)  
[integralife.eu/contact](http://integralife.eu/contact)

MicroFrance, Integra et le logo Integra sont des marques enregistrées de Integra LifeSciences Corporation ou de ses filiales aux USA et/ou dans d'autres pays. Toutes les autres marques et noms de produits sont la propriété de leurs propriétaires respectifs.  
© 2023 Integra LifeSciences Corporation. Tous droits réservés.

0321372-5-FR

DOCUMENT DESTINE A L'EUROPE, AU MOYEN-ORIENT ET A L'AFRIQUE UNIQUEMENT.