



## AESTHETIC

MICRO CANULE / MICRO CANNULA	6
KIT MICRO CANULE + AIGUILLE / MICRO CANNULA KIT	7
AIGUILLES / NEEDLES	8
SERINGUES 0,3ML + AIG. 32G & RACCORD / 0.3ML SYRINGES + N. 32G & CONNECTOR	9
SERINGUES / SYRINGES {1ml // 3-5-10-20-30-50/60ml}	10
RACCORDS & BOUCHONS / CONNECTOR & CAPS	12
GEL & MEMBRANE / GEL & MEMBRANE	13
PANSEMENT SILICONE / SILICONE PATCH	14
THERMOTHÉRAPIE PRÉ/POST-ACT / PRE/POST ACT THERMOTHERAPY	15
CRYOCHIRURGIE / CRYOSURGERY	16
MULTITOX POUR INJECTION DE TOXINE BOTULIQUE / MULTITOX FOR BOTULINUM TOXIN INJECTION	17
SYSTÈME MICRO NEEDLING + ELECTROPORTATION / EPN	18



## SURGE

CANULE DE PRÉLÈVEMENT DE TISSU GRAISSEUX / CANNULA FOR FAT HARVESTING	22
CANULE D'INJECTION SOUS-CUTANÉ / CANNULA FOR FAT INJECTION	23
CANULES DE LIPOMODELAGE POUR LE CORPS / LIPOMODELING CANNULAS FOR THE BODY	24
CANULE DE TRANSFERT & TYPE MOREL / TRANSFER CANNULA & MOREL TYPE	25
KIT MICROLIPOSCULPTURE & LIPOFILLING / MICROLIPOSCULPTURE & LIPOFILLING KIT	26
CANULE LIPO ASPIRATION / LIPOSUCTION CANNULA LIPO-ONE®	27
TUBE / TUBING	28
BOCAL COLLECTEUR DE GRAISSE / FAT COLLECTOR CANISTER	29
ACCESSOIRES RÉUTILISABLES / REUSABLE ACCESSORIES	30
SUPPORT SERINGUES & TUBES / SYRINGES & TUBES HOLDER	31
CENTRIFUGEUSE MANUELLE / MANUAL CENTRIFUGE LIPO-ONE®	32
POMPE PERISTALTIQUE / PERISTALTIC PUMP	34
INFILTRATION / INFILTRATION	35
PISTOLET D'INJECTION / REINJECTION GUN	36
VÊTEMENTS CONTENTION / CONTENTION GARMENT	37
GAMME TRCHANTE / SHARP RANGE	40
PRP - CENTRIFUGEUSE 10ml - ACCESSOIRES / PRP - 10ml centrifuge - Accessories	42
PLASMA RICHE EN PLAQUETTE / PLATELET-RICH PLASMA - CELLENIS PRP™	43

# S U M M A R Y



## DERMA

PUNCH A BIOPSIE & CURETTE / BIOPSY PUNCH & CURETTE	46
PUNCH / CURETTE & LAME BIOPSIE KAI / PUNCH / CURETTE & BIOPSY BLADE KAI	47
CURETTE DERMATOLOGIQUE / DERMATOLOGICAL CURETTE	48
AURATIO® / WOUND NANO NEEDLE STAMP 0.5 & 1.0mm (NANONEEDLING)	49
ROLLER DERMIQUE / SKIN ROLLER	50
LAMPE FRONTALE & LOUPE / HEAD LIGHT NSE	51
PROTECTION LED - LASER - IPL / LASER - IPL - UV SAFETY	52



## MESO

PISTOLET D'INJECTION "PRECISE" / MESO & INJECTION GUN "PRECISE"	58
CATHÉTERS / CATHETER	60
AIGUILLES / TUBULURES / NEEDLES / TUBING	61
"PIEUVRES" MESALYSE® / MESALYSE® "OCTOPUS"	62



## BEAUTY

MASQUE INEX / INEX MASK	66
-------------------------	----

<b>MICRO CANULE / MICRO CANNULA</b>	6
<b>KIT MICRO CANULE + AIGUILLE / MICRO CANNULA KIT</b>	7
<b>AIGUILLES / NEEDLES</b>	8
<b>SERINGUES 0,3ML + AIG. 32G &amp; RACCORD / 0.3ML SYRINGES + N. 32G &amp; CONNECTOR</b>	9
<b>SERINGUES / SYRINGES {1ml // 3-5-10-20-30-50/60ml}</b>	10
<b>RACCORDS &amp; BOUCHONS / CONNECTOR &amp; CAPS</b>	12
<b>GEL &amp; MEMBRANE / GEL &amp; MEMBRANE</b>	13
<b>PANSEMENT SILICONE / SILICONE PATCH</b>	14
<b>THERMOTHÉRAPIE PRÉ/POST-ACT / PRE/POST ACT THERMOTHERAPY</b>	15
<b>CRYOCHIRURGIE / CRYOSURGERY</b>	16
<b>MULTITOX POUR INJECTION DE TOXINE BOTULIQUE / MULTITOX FOR BOTULINUM TOXIN INJECTION</b>	17
<b>SYSTÈME MICRO NEEDLING + ELECTROPORATION / EPN</b>	18





# AESTHETIC



# MICRO CANULE

## MICRO CANNULA

Dispoderm®

L'extrémité mousse permet une introduction atraumatique, réduisant tout risque d'hématome.

Les canules sont fabriquées en acier inoxydable de haute qualité, à paroi fine et ont une surface lisse pour une introduction facile et atraumatique.

L'embase de la canule à une forme ergonomique pour faciliter la manipulation pendant l'insertion et le retrait et un code couleur en fonction du diamètre de la canule.

L'orifice latéral à l'extrémité de la canule permet d'assurer une injection dirigée du produit.

Méthode de stérilisation : Oxyde d'éthylène.

The blunt tip is used for atraumatic introduction, thus reducing risk of hematoma.

The thin-walled cannulas, made of high quality stainless steel, have a smooth surface to ensure atraumatic introduction.

The hub is ergonomically shaped and allows smooth manipulation during insertion and removal of the cannula. It is color coded according to the diameter of the cannula.

The lateral opening on the tip of the cannula ensures precise injection of the product.

Sterilisation method: EO (Ethylene Oxide)



THIN WALL  
KR series



REF.	Ø (Gauge / mm)	Longueur Length (mm)	Couleur Color
M118110KR		110	
M11890KR	<b>18G</b> /1,25mm	90	●
M11870KR		70	
M12170KR	<b>21G</b> /0,81mm	70	●
M12140KR		40	
M12290KR		90	
M12270KR	<b>22G</b> /0,70mm	70	●
M12250KR		50	
M12370KR	<b>23G</b> /0,63mm	70	●
M12350KR		50	
M12450KR	<b>24G</b> /0,55mm	50	●
M12438KR		38	
M12550KR	<b>25G</b> /0,50mm	50	●
M12650KR		50	
M12638KR	<b>26G</b> /0,45mm	38	●
M12625KR		25	
M12740KR	<b>27G</b> /0,40mm	40	●
M13025*	<b>30G</b> /0,30mm	25	●

\*Embase luer lock standard - \*Standard luer lock hub

# KIT MICRO CANULE + AIGUILLE

## MICRO CANNULA KIT

Dispoderm

La dernière évolution  
en micro canule d'injection !  
The latest evolution of the  
micro cannula !



REGULAR  
KS series



THIN WALL  
KR series



ULTRA THIN  
WALL  
KE series

Chaque kit contient une micro canule et une aiguille de même diamètre.  
Each kit contains a micro cannula and a needle of the same diameter.



		REF.	Ø Ext. (Gauge / mm)	Ø Int. (mm)	Longueur Length (mm)
REGULAR WALL (KS)		MI2170 KS	<b>21G</b> / 0,81mm	0.50	70
		MI2250 KS	<b>22G</b> / 0,70mm	0.40	50
		MI2550 KS	<b>25G</b> / 0,50mm	0.25	50
		MI2740 KS	<b>27G</b> / 0,40mm	0.20	40
ULTRA THIN WALL (KE)		MI2170 KE	<b>21G</b> / 0,81mm	0.70	70
		MI2250 KE	<b>22G</b> / 0,70mm	0.60	50
		MI2550 KE	<b>25G</b> / 0,50mm	0.40	50
		MI2740 KE	<b>27G</b> / 0,40mm	0.30	40

34G

32G

33G



### AIGUILLES MÉDECINE ESTHÉTIQUE AESTHETIC NEEDLES

kipic™

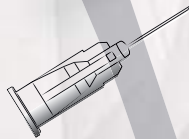

REF.	∅ (Gauge / mm)	Long. Length (mm)	Couleur Color
KIPIC33G13	0,21/ <b>33G</b>	13	●
KIPIC33G08	0,21/ <b>33G</b>	8	●
KIPIC33G04	0,21/ <b>33G</b>	4	●
KIPIC32G13	0,23/ <b>32G</b>	13	●
KIPIC32G08	0,23/ <b>32G</b>	8	●
KIPIC32G04	0,23/ <b>32G</b>	4	●
KIPIC30G13	0,30/ <b>30G</b>	13	●
KIPIC30G04	0,30/ <b>30G</b>	4	●
KIPIC27G13	0,40/ <b>27G</b>	13	●
KIPIC27G04	0,40/ <b>27G</b>	4	●
MN34G8	0,18/ <b>34G</b>	8	●
MN31G12	0,26/ <b>31G</b>	12	●
MN31G6	0,26/ <b>31G</b>	6	●
MN31G4	0,26/ <b>31G</b>	4	●
KIPIC30G25	0,30/ <b>30G</b>	25	●
KIPIC27G42	0,40/ <b>27G</b>	42	●
KIPIC25G42	0,50/ <b>25G</b>	42	●
300780	1,60/ <b>16G</b>	25	●
300779	1,25/ <b>18G</b>	40	●

### MICRO INJECTION MICRO-INJECTION

### NOKOR™ NOKOR™

SERINGUES 0,3ml + AIGUILLE 32G & RACCORD

0.3ml SYRINGES + NEEDLE 32G & CONNECTOR

Love*l*iness

Drc  
Perfect your beauty

# Love*l*iness



La 1<sup>ère</sup> seringue de **0,3ml** avec une aiguille sertie de **32G** dédiée exclusivement au domaine esthétique

The 1<sup>st</sup> **0.3ml** syringe with a **32G** needle set dedicated exclusively to the aesthetic field



2 x50

REF. Ø Long. (Gauge / mm) Length (mm)

Seringue 0,3ml + Aiguille  
0.3 ml Syringe Needle

→ 32Gx10mm 1G3210 32G 10  
→ 32Gx13mm 1G3213 32G 13

2 x100

REF.

RACCORD FEMELLE LUER LOCK EXCLUSIF LOVELINESS®  
EXCLUSIVE LOVELINESS® CONNECTOR FOR TRANSFER

DFL05







REF.

### SERINGUE LUER LOCK LUER LOCK SYRINGE

1ml



LUER LOCK  
Polypropylène  
Piston pointu / Pin tip

L10100



LUER SLIP  
Polypropylène  
Piston pointu / Pin tip

S10100



### SERINGUE BD SYRINGE



REF.	Volume ml	Nbre pcs Qty
309658	3	200
309649	5	125
300912	10	100
300629	20	120
301229	30	60
300865	50/60	60

# SERINGUES

## SYRINGES



### SERINGUE TOOMEY TOOMEY SYRINGE

60ml

REF.

MSS160T



### SERINGUE VACLOK™ VACLOK™ SYRINGE

REF.

Volume (ml)

VAC110	10
VAC130	30
VAC160	60





REF.

### RACCORD FEMELLE LUER LOCK POUR MÉLANGE DE GEL CONNECTOR FOR GEL TRANSFER

993922R



Ø int. = 1.8mm



### RACCORD FEMELLE LUER LOCK POUR TRANSFERT DE GRAISSE CONNECTOR FOR FAT TRANSFER

993922T



Ø int. = 2.5mm



### BOUCHON LUER LOCK CAP

MLL



FLL

REF.  
MC1711



### MEMBRANE POUR TRAITEMENT DE CRYOLIPOLYSE MEMBRANE FOR CRYOLIPOLYSIS

Membrane imprégnée de gel antigivrant pour les traitements avec l'appareil de cryolipolyse.  
*Membrane impregnated with anti freeze gel for cryolipolysis treatments.*

Température d'utilisation jusque -10°C  
*Operating temperatures up to 10°C*

Une seule utilisation  
*For single use only*

Matériel jetable  
*Disposable*

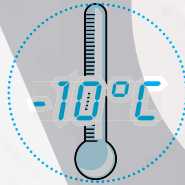

REF.      Format cm

CRYOMB      28x28

CRYOMB+      34x42



### GEL POUR CRYOLIPOLYSE CRYOLIPOLYSIS GEL

#### Gel pour Cryolipolyse, 1 kg

Gel transparent, pour l'hydratation, la lubrification et la protection avec les appareils de froid.

**Composition :** eau, alcool Denat, glycérine, carbomer, TRIÉTHANOLAMINE

Température d'utilisation jusque -5°C

#### Cryolipolysis gel, 1 kg (2.2 lb)

*High transparency gel for hydration, lubrication and protection for cold equipment.*

**Composition:** aqua, alcohol Denat, glycerin, carbomer, TRIETHANOLAMINE

*Operating temperature up to -5°C*



REF.  
CRG1000

# silicare

**LIPO** Ø 3,75

**XS** 2,5 x 2,5 cm

**S** 5 x 7,5 cm

**M** 5 x 18 cm

**L** 15 x 18 cm

**XL** 38 x 38 cm

**NIPPLE** Ø Ext : 7,5 / Int : 1,8 cm

**Abdo** 5 x 38 cm

**Breast** 5 x 30 cm

**PANSEMENT CICATRISANT NON STÉRILE, USAGE UNIQUE**

- Composants du produit :
- Silicones transparents 200g/m<sup>2</sup> (± 15%)
  - Vitamine E (0,1%)
  - Couche de polyuréthane transparent 60µm
  - Film de protection : fixation par pelage, film PVC 100µm
- Caractéristiques du produit :
- Épaisseur totale de la feuille : 250um (± 20%)

*NON-STERILE SCAR MANAGEMENT DRESSING. SINGLE USE*

- Product components:
- Transparent silicones 200g/m<sup>2</sup> (±15%)
  - Vitamin E (0.1%)
  - Polyurethan layer transparent 60µm
  - Protection film: peel off fixation. PVC film 100µm
- Product characteristics:
- Total thickness of the sheet: 250um (±20%)



Silicare® : Mince feuille de silicone pour le traitement des cicatrices, enrichi en vitamine E.

Silicare® : Thin silicone sheet for scar treatment, enriched with vitamin E.

REF.	Dimension (cm)	Quantité
Sili - LIPO	Ø 3,75	<b>x6</b>
SiliPatch-XS	2,5 x 2,5	
SiliPatch-S	5 x 7,5	
SiliPatch-M	5 x 18	
SiliPatch-L	15 x 18	
SiliPatch-XL	38 x 38	<b>x1</b>
Sili-NIPPLE	Ø Ext : 7,5 / Int : 1,8	
Sili- Abdo	5 x 38	
Sili-Breast	5 x 30	

# THERMOTHÉRAPIE PRÉ/POST-ACT

PRE/POST ACT THERMOTHERAPY

Aesthetic  
Group

## ICE-STICK AESTHETIC COOLING MASSAGER

Un nouveau concept pour des massages rafraîchissants avec une cartouche glacée.  
Ice-Stick pour visage et corps.  
La meilleure solution pour apaiser et rafraîchir la peau.

*New concept cooling massager with ice cartridge.  
Ice-Stick supports to keep your skin fresh performing cooling massage.  
The best way to cool down & soothe your skin.*

**Permet d'insérer une aiguille sans douleur et d'atténuer les risques d'hématomes.**

*To insert needle without any pain and reduce haematomas.*



REF.

ICE-STICK

x1

## MASQUE ET CARRÉ RAFRAICHISSANTS

COOLING SQUARE AND MASKS INFILTRATION TUBING



L11



L14

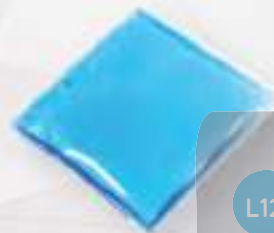

L12

L11 - Visage

L14 - Yeux

L12 - Carrés



## SKIN COOLER



REF.

SCB

SKIN COOLER BODY  
LARGEUR 5,5 CM

Calme la peau avant / après les injections.  
Peut être utilisé pour répartir le gel avant un traitement de LASER, cela permet d'améliorer la circulation et augmente l'apport en oxygène.

*Perfect before / after injection.  
Can be used to spread the gel before laser treatment. increase blood circulation and oxygenation.*



REF.

SCF

SKIN COOLER FACE  
LARGEUR 3 cm

## SPRAY RÉFRIGÉRANT

COLD SPRAY



SPR 400

Volume 400ml



### CRYOCHIRURGIE POINTE FINE CRYOSURGERY FINE TIP

Cryoalfa SUPER avec pointe en vitrocéramique 1mm + 1 cartouche, dans un blister.

*Cryoalfa SUPER with ceramic tip of 1 mm + 1 cartridges, packaged in a blister.*



REF.

CA-S-L



### CRYOCHIRURGIE APPLICATEUR LARGE CRYOSURGERY LARGE TIP

Cryoalfa SUPER CONTACT avec applicateur contact pour une zone de 5mm de diamètre + 1 cartouche, dans un blister.

*Cryoalfa SUPER CONTACT with contact tip of 5 mm in diameter + 1 cartridge, packaged in a blister.*



CA-S-C5

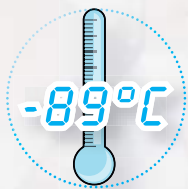

CA-K-V16



### NITRO-SPRAY CRYOPRO®

L'azote liquide est le plus largement utilisé dans la cryochirurgie moderne.

*Liquid nitrogen is the most widely used coolant in modern cryosurgery.*

Vendu vide (Sans azote liquide)  
Sold empty (without liquid nitrogen)

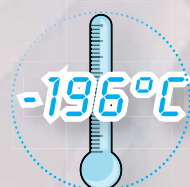

Description

REF.

Cryopro® MINI 0,35L CX.CP.MNI  
Cryopro® MAXI 0,5L CX.CP.MAXI

Chacun fournis avec :  
x5 embouts (Ø : 1mm / 0,75mm / 0,55mm / 0,4mm  
+ embout long courbe)  
x1 adaptateur de nettoyage

Provided with:  
x5 Spray tips (Ø : 1mm / 0.75mm / 0.55mm / 0.4mm  
+ bent probe)  
x1 Cleaning adapter



NEW

**MULTITOX** pour injection de toxine botulique

*MULTITOX For botulinum toxin injection*

**MultiTox™**

**Exclusive**

# MultiTox™

Un dispositif innovant pour les seringues botuliques  
*An innovative device for botulinum syringes*

**EFFICACITÉ  
&  
SÉCURITÉ**

**EFFICACY  
&  
SAFETY**

Résultats  
des  
traitements  
améliorés

*Improved  
treatment  
results*

haute précision  
d'injection

*Highly  
accurate injections*

Moins de 1 Euro  
par patient

*Less than 1 Euro  
per patient*



REF.

Avec le **MultiTox**, l'injection de toxine botulique est maintenant une procédure simple à effectuer avec une précision du dosage (0,025ml ou 0,05ml).  
Jusqu'à 40 injections par dispositif.

*With the **MultiTox**, botulinum toxin injection is actually simple to perform with dosage accuracy (0.025ml ou 0.05ml).  
Up to 40 injections with the same device.*



MULTITOX-1



MULTITOX-6



**LE PREMIER DISPOSITIF INTÉGRANT LE SYSTÈME  
MICRO-NEEDLING AVEC L'ÉLECTROPORATION**

*THE FIRST DEVICE INTEGRATING THE MICRO-NEEDLING  
SYSTEM WITH ELECTROPORATION*



- Régénération des cheveux
- Amélioration de l'aspect de la peau
- Éclaircissement de la peau
- Raffermissement de la peau
- Contraction des pores
- Améliorer les rides

- Hair regeneration
- Improving skin aspect
- Skin brightening
- Skin firming
- Pore contraction
- Improving wrinkle

**SPECIFICATION**

Type	<i>Electroporation &amp; Micro Needling</i>
Needling RPM	<i>1 Level : 4.000 / 2 Level : 4.500 / 3 Level : 5.000</i>
Depth of needle	<i>0 mm ~ 2.0 mm</i>
Needle cage	<i>33G</i>
Electroporation	<i>5 intensity levels</i>
Needle	<i>Disposable sterilized needle</i>

Ceci n'est pas un dispositif médical - *This is not a medical device*

REF.

Système avec aiguille électroporation  
*Electroporation needle system*



EPN

Électrode 9 aiguilles à usage unique pour EPN  
*Disposable electrode 9 needles for EPN*

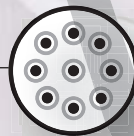

EPN\_NEEDLE

∅ = 0,16 x 11 mm



# Eunsung



#### Principe de l'EPN :

Lorsque les micro-aiguilles injectent des électrodes à une profondeur de 0-2 mm sous la surface de la peau, il induit une distribution précise du complexe cosmétique à travers les pores.

L'électrode micro-aiguille induit l'électroporation instantanément pour délivrer un complexe cosmétique à travers les micropores sur les membranes de fibroblastes dermiques.

#### PRINCIPLE OF EPN :

When injection micro needles electrodes at 0-2mm depth below the skin surface, it induces precise complex cosmetic delivery throughout pores.

Micro needle electrode induces electroporation instantly to deliver a complex cosmetic throughout micro pores on the dermal fibroblast membranes.

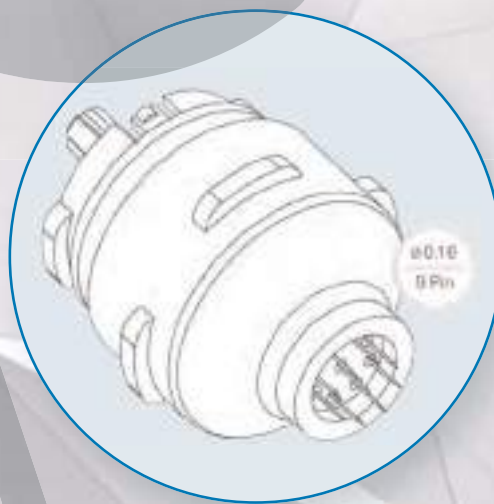
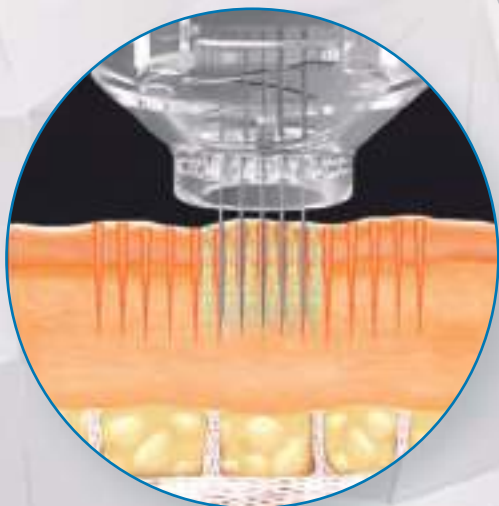

<b>CANULE DE PRÉLÈVEMENT DE TISSU GRAISSEUX / CANNULA FOR FAT HARVESTING</b>	22
<b>CANULE D'INJECTION SOUS-CUTANÉ / CANNULA FOR FAT INJECTION</b>	23
<b>CANULES DE LIPOMODELAGE POUR LE CORPS / LIPOMODELING CANNULAS FOR THE BODY</b>	24
<b>CANULE DE TRANSFERT &amp; TYPE MOREL / TRANSFER CANNULA &amp; MOREL TYPE</b>	25
<b>KIT MICROLIPOSCULPTURE &amp; LIPOFILLING / MICROLIPOSCULPTURE &amp; LIPOFILLING KIT</b>	26
<b>CANULE LIPO ASPIRATION / LIPOSUCTION CANNULA LIPO-ONE®</b>	27
<b>TUBE / TUBING</b>	28
<b>BOCAL COLLECTEUR DE GRAISSE / FAT COLLECTOR CANISTER</b>	29
<b>ACCESSOIRES RÉUTILISABLES / REUSABLE ACCESSORIES</b>	30
<b>SUPPORT SERINGUES &amp; TUBES / SYRINGES &amp; TUBES HOLDER</b>	31
<b>CENTRIFUGEUSE MANUELLE / MANUAL CENTRIFUGE LIPO-ONE®</b>	32
<b>POMPE PERISTALTIQUE / PERISTALTIC PUMP</b>	34
<b>INFILTRATION / INFILTRATION</b>	35
<b>PISTOLET D'INJECTION / REINJECTION GUN</b>	36
<b>VÊTEMENTS CONTENTION / CONTENTION GARMENT</b>	37
<b>GAMME TRCHANTE / SHARP RANGE</b>	40
<b>PRP - CENTRIFUGEUSE 10ml - ACCESSOIRES / PRP - 10ml centrifuge - Accessories</b>	42
<b>PLASMA RICHE EN PLAQUETTE / PLATELET-RICH PLASMA - CELLENIS PRP™</b>	43





# SURGE

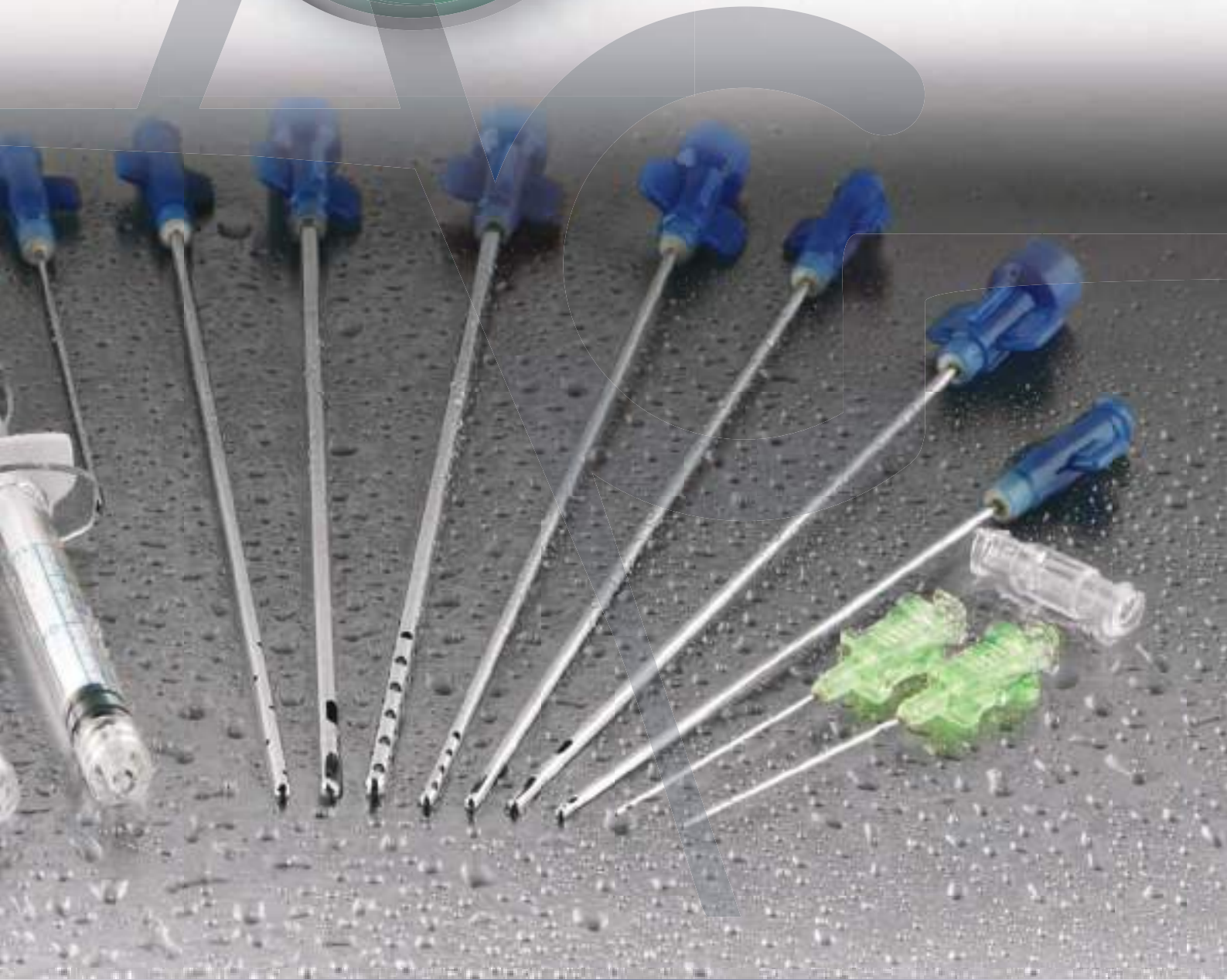

# CANULE DE PRÉLÈVEMENT DE TISSU GRAISSEUX

## CANNULA FOR FAT HARVESTING

Aesthetic  
Group

	REF.	Orifices Hole	Ø(mm)	Longueur Length (mm)
	CP 3 2 3 0 1	1	3,00	230
	CP 4 2 3 0 1		4,00	230
V-SPATULA	CP 16 9 0 V	1	1,65	90
	CP 16 15 0 V		1,65	150
	CP 14 9 0 V		2,10	90
	CP 14 15 0 V		2,10	150
	CP 3 0 1 5	2	3,00	150
	CP 3 0 2 3		3,00	230
SPIRAL	CP 17 8 5 3 HS	3	1,45	85
	CP 16 10 5 3 HS		1,65	105
	CP 14 12 5 3 HS		2,10	125
	CP 3 0 1 5 3 S		3,00	150
	CP 14 12 5 3 HV	3	2,10	125
	CP 3 1 5 0 3 M		3,00	150
	CP 3 2 3 0 3 M		3,00	230
MERCEDES	CP 4 2 3 0 3 M	3	4,00	230
	CP 3 2 3 0 3 T		3,00	230
	CP 4 2 3 0 3 T	4	4,00	230
	CP 14 1 3 0 4 H		2,10	130
	CP 3 0 1 5 4 H	4	3,00	150
	CP 14 1 2 5 6 HMP		2,10	125
	CP 14 1 5 0 6 HS	6	2,10	150
	CP 3 5 1 7 6 H		3,50	170
	CP 1 2 2 0 0 7 H	7	2,80	200
	CP 1 2 3 0 0 7 H		2,80	300
	CP 14 1 5 0 8 H	8	2,10	150
RUGUEUSE	ROUGH CP 3 0 1 5 1 2 R		12	3,00
	CP 3 0 1 5 2 4 H	3,00		150
	CP 3 0 2 3 2 4 H	24		3,00

# CANULE D'INJECTION SOUS-CUTANÉ

## CANNULA FOR FAT INJECTION

Aesthetic  
Group

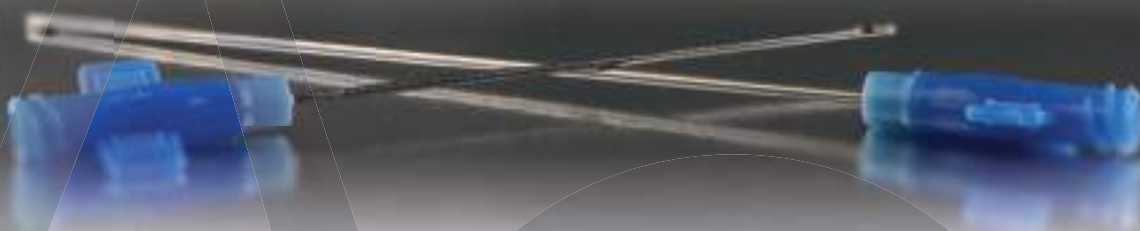

2 x10

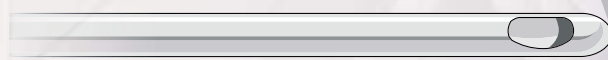
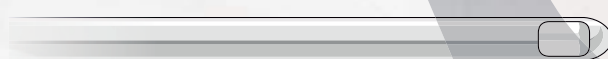
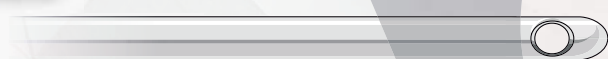

REF.	Orifices degré ouverture Hole	Ø(mm)	Longueur Length (mm)
CF0965290	2	0,90	65
CFL201502LE		2,10	150
CF15745	1/45°	1,65	70
CF151045		1,65	100
CF201545		2,10	150
CF202345		2,10	230
CF10790	1/90°	1,05	70
CF12790		1,25	70
CF14790		1,45	70
CF15790		1,65	70
CF151090		1,65	100
CF16890		1,85	80
CF201090		2,10	100
CF201590		2,10	150
CF202290		2,10	220
CF27990		2,75	90
CF271590	2,75	150	
CF301590	3,00	150	
CF301990	3,00	190	
CF401990	4,00	190	

# CANULES DE LIPOMODELAGE POUR LE CORPS

LIPOMODELING CANNULAS FOR THE BODY

Aesthetic  
Group



12 Orifices / Holes



\* Canule incurvée / Curved cannula

REF.	Ø(mm)	Long. Length (cm)
CP142012	2	20
CP142512	2	25
CP143012	2	30
CP112012	3	20
CP112512	3	25
CP113012	3	30
CF141590 SP	2	15
CF142090 SP	2	20
CF142590 SP	2	25
CF142090 CSP*	2	20
CF142590 CSP*	2	25
CF111590 SP	3	15
CF112090 SP	3	20
CF112590 SP	3	25
CF112090 CSP*	3	20
CF112590 CSP*	3	25
CF1420 BF	2	20
CF1425 BF	2	25
CF1120 BF	3	20
CF1125 BF	3	25

# CANULE DE TRANSFERT & TYPE MOREL

## TRANSFER CANNULA & MOREL TYPE

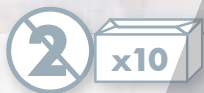

### CANULE MICRO LIPO TRANSFERT LIPO TRANSFER CANNULA



REF. Ø(mm) Longueur  
Length  
(mm)

MF11180	2,50	109
MF11182	1,65	65
MF11183	1,65	75
MF11184	1,65	75

### CANULE TRANSFERT AUTOLOGUE DE GRAISSE AUTOLOGOUS FAT TRANSFER CANNULA



CPOE18100	1,24	100
CPOE3155	3,00	155
CPOE3195	3,00	195
CPOE3275	3,00	275
CPOE3300	3,00	300

### CANULE OLIVAIRE OLIVARY CANNULA



AL701	2,10	210
AL702	2,10	150



# KIT LIPOSCULPTURE

## LIPOSCULPTURE KIT

Aesthetic  
Group

2 x1

### PACK MICROLIPOSCULPTURE MICROLIPOSCULPTURE PACK

Dispositif stérile individuellement  
Individually sterile device



2 x5

### PACK DE GREFFE ADIPOCYTAIRE MAMMAIRE MAMMARY ADIPOCYTE GRAFTING PACK



1 canule d'infiltration  
1 canule de lipoaspiration  
2 canules lipo transfert  
2 tubulures d'aspiration  
18 bouchons LL  
18 seringues 50-60 ml luer embout conique  
1 bistouri  
1 barquette  
1 champ opératoire (150x150 cm)

1 infiltration cannula (2,5 mm x 300 mm - 10 orifices / holes) (CI25300)  
1 liposuction cannula (4 mm x 280 mm - 3 orifices / holes) (LC42803)  
2 lipo transfer cannula 21 mm x 230 mm - 1 orifice / hole 45° (CF202345)  
2 liposuction tubing (intern 7 mm & exter 10 mm x 2m) (ST 30200))  
18 caps LL  
1 syringe luer conical end 50-60 ml  
1 Scalpel N°1  
1 Container  
1 Operating field (150x150 cm)

REF.

KLF000

REF.

Ø(mm) Orifice Hole Longueur Length (mm)

Canule de prélèvement  
Cannula for fat harvesting

CP141508H

2.10

8

150

2 microcannules de réinjection  
2 reinjection micro cannulas

2x MI2140KR

0,81

1

40

Raccord  
FLL connector

993922T

REF.

401448



# Lipo-one®

by ipeh



REF.	Orifices Hole	Ø(mm)G	Longueur Length (mm)
LC 313 02	2	3,00	130
LC 323 02		3,00	230
LC 423 02		4,00	230
LC 428 02		4,00	280
LC 528 02		5,00	280
LC 628 02		6,00	280
LC 313 03	3	3,00	130
LC 323 03		3,00	230
LC 423 03		4,00	230
LC 428 03		4,00	280
LC 528 03		5,00	280
LC 628 03		6,00	280
LC31503HVS	3	3,00	150
LC32303HVS		3,00	230
LC 3130 4H	4	3,00	130
LC32804H		3,00	280
LC313024H	24	3,00	130
LC328024H		3,00	280
LC428024H		4,00	280



### TUBE ASPIRATION STERILE LIPOSUCTION TUBING



REF.	Ø int. (mm)	Ø ext. (mm)	Longueur Length (cm)
ST30200	7,00	10,00	200
ST30300	7,00	10,00	300

HIGHFLOW

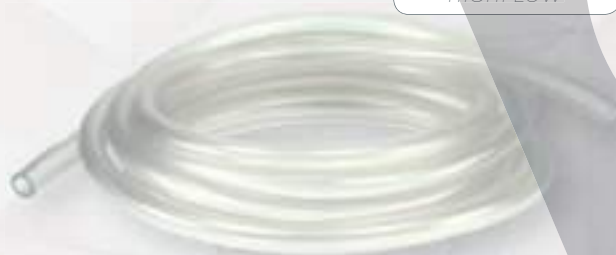

HFST813300 8,00 13,00 300

### TUBULURES SILICONE AUTOCLAVABLE SILICONE TUBING AUTOCLAVABLE



TS1325	1,00	3,00	
TS2425	2,00	4,00	
TS3610	3,00	6,00	
TS5925	5,00	9,00	10m
TS7122	7,00	12,00	
TS81410	8,00	14,00	
TS12182	12,00	18,00	

Livré NON STERILE  
NON STERILE delivered



### BOCAL COLLECTEUR DE GRAISSE AUTOCLAVABLE ET RE-STÉRILISABLE

- Couvercle flotteur sont également autoclave
- Flotteur de sécurité pour empêcher le débordement
- Connecteur Luer Lock situé à la base

### AUTOCLAVABLE & REUSABLE FAT COLLECTOR CANISTER

- Lid and float are also autoclavable
- Safety float to prevent overflow
- Luer Lock connector located on the bottom



AUTOCLAVABLE  
REUTILISABLE

#### LE KIT CONTIENT\* :

- 1 bocal - 1 couvercle
  - 10 tubes usage unique avec clamp/robinet
  - 1 support inox
  - 1 tube silicone autoclavable pour faire le vide
- Autoclavable et re-stérilisable.

#### THE KIT CONTAINS\*:

- 1 Canister - 1 Lid
  - 10 Disposable Tubes with Clamp/Stopcock
  - 1 Stainless Steel Stand
  - 1 Reusable Vacuum Silicon Tube
- Autoclavable and re-usable.

\*Chaque élément peut être acheté séparément.  
\*Each item can be sold separately.  
[www.aestheticgroup.fr](http://www.aestheticgroup.fr)

REF.	Volume (L)
SB 2 5 0	0,25
SB 5 0 0	0,5
SB10 0 0	1
SB2000	2
SB3000	3

**TUBE 17CM - CLAMP - ROBINET**  
TUBE 17CM - CLAMP - STOPCOCK

TRSB 170



### MESUREUR DE GRAISSE SOUS CUTANÉE ÉLECTRONIQUE MEASUREMENT OF SUBCUTANEOUS FAT TISSUE

Rang : 0 - 50 mm / 0 - 2»  
 Résolution : 0,1 mm / 0,01»  
 Précision : +0,2 mm / 0,01»  
 Température de travail : 0°C à 40°C  
 Température de garde : -20°C à +70°C  
 Piles : 3V (inclues).

Range : 0 - 50 mm / 0 - 2»  
 Resolution : 0.1 mm / 0.01»  
 Accuracy : +0.2 mm / 0.01»  
 Working temperature : 0°C to 40°C / 32 °F to 104 °F  
 Storage temperature : -20°C to +70°C / -4 °F to 158  
 Battery : 3V (included).

Plicomètre électronique  
 pour la mesure de la graisse  
 sous-cutané.

Electronic skinfold caliper -  
 measurement  
 of subcutaneous fat tissue.



REF.

ELEKCAL



### MESUREUR DE GRAISSE SOUS CUTANÉE SKINFOLD CALIPER-MEASUREMENT OF SUBCUTANEOUS FAT TISSUE

Plicomètre pour mesure  
 de la graisse sous cutanée  
 Rang de mesure 0 - 70 mm.

Lightweight and easy to transport.  
 Measuring Range 0 - 70 mm.



SKINCAL



### RUBAN DE MESURE POUR PÉRIMÈTRE + IMC MEASURING TAPE + BMI



MTBMI



# SUPPORT SERINGUES & TUBES

## SYRINGES & TUBES HOLDER

### SUPPORT INOX STAINLESS STEEL RACK

POR6383 : L 12 x l 6.5 x H 8.3cm

POR36113 : L 21.5 x l 10.5 x H 11.3cm



REF.	Tubes	Seringue Syringe
POR6383	3x6	1ml/10ml
POR36113	3x6	1ml à/to 50ml



### SUPPORT INOX POUR 5 SERINGUES STAINLESS STEEL RACK FOR 5 SYRINGES

Support acier inoxydable pour seringue 1ml à 10ml.  
*Stainless steel rack for 1ml to 10ml syringes.*



REF.  
SS5C



### SUPPORT POUR SERINGUE SYRINGE HOLDER

Support solide et en toute sécurité pour seringues d'injection  
Risque de blessures réduit

*Solid safety stand for injection syringes  
Reduces injury risk*



REF.  
355466





REF.

### CMone

Centrifugeuse + Boite de stérilisation  
Centrifuge + Sterilization box

Fabriquée en Aluminium et acier inoxydable anodisé, la centrifugeuse **CMone** est entièrement **autoclavable**.

Cette centrifugeuse manuelle LIPO-one® de dernière génération est ultra polyvalente avec ses supports adaptés aux seringues de **5, 10, 20 & 60ml**.

Idéale pour la centrifugation de la graisse ou tissu adipeux / pour une utilisation en lipofilling, liposculpture ou lipomodelage.

*Made of aluminum and anodized stainless steel.  
The **CMone** centrifuge is fully **autoclavable**.*

*This latest-generation LIPO-one® manual centrifuge is ultra-polyvalent with syringe holders for **5, 10, 20 & 60ml**.*

*Ideal for the centrifugation of fat or adipose tissue / for the use in lipofilling, liposculpture or lipomodelage.*

#### Composants / Components :

- 4x supports de seringues 60ml
- 4x supports de seringues 20ml
- 4x supports de seringues 10 et 5ml
- 1x support de fixation sur table d'opération
  
- 4x syringe holders 60 ml
- 4x syringe holders 20 ml
- 4x supports of 10 and 5ml
- 1x operating table mounting bracket



La centrifugeuse est livrée avec sa boîte de stérilisation / rangement.  
(134° à l'autoclave)

*The centrifuge is delivered with its box sterilization / storage.  
(134 ° autoclave)*







### POMPE PERISTALTIQUE PERISTALTIC PUMP

REF.	Débit (ml/min) Flow rate	Vitesse Speed (rpm)
BT600M	0.007 > 2280	0.1 > 600

#### Caractéristiques :

Vitesse du moteur d'affichage numérique à 3 LED.

Basculer la commande de marche / arrêt et la direction du commutateur.

Vitesse de commande de commutateur rotatif, opération facile.

Économique et durable, adapté à différentes applications.

Garantie : 3 ans.



Paramètre technique Technical parameter	Données techniques Technical data
<b>Vitesse</b> Speed Range	0,1 - 600 rpm
<b>Débit</b> Flowrate Range	0,0015 - 2280 ml/min
<b>Courant</b> Power Supply	AC220V +/- 10%
<b>Consommation d'énergie</b> Power Consumption	< 50W
<b>Température d'utilisation</b> Condition Temperature	0-40°C
<b>Humidité relative</b> Relative Humidity	< 80%
<b>Dimensions (Long. x larg. x Haut.)</b> Dimension (L x W x H)	254 x 184 x 145 mm
<b>Poids</b> Weight	4,64 kg

#### Features :

3 digital LED display motor speed.

Toggle switch control start/ stop and direction.

Rotary encoded switch control speed, easy operation.

Economical and durable, suitable for different application.

Warranty : 3 years.



### CANULE POUR INFILTRATION CANNULA FOR INFILTRATION



REF.	Ø (mm)	Longueur Length (mm)
CI16150	1,65	150
CI18100	1,25	100
CI21100	2,10	100
CI21150	2,10	150
CI21250	2,10	250
CI25150	2,50	150
CI25250	2,50	250
CI25300	2,50	300



### MANCHETTE POUR INFILTRATION AVEC MANOMÈTRE PRESSURE INFUSOR

Manchette de pression avec poire et robinet 3 voies.  
*Three way stopcock that prevents air leaks.*



REF.  
MX4810P1

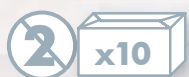

### TUBULURE POUR POMPE PÉRISTALTIQUE PERISTALTIC PUMP TUBING



TP01



### TUBULURE POUR INFILTRATION INFILTRATION TUBING



DIT

# PISTOLET D'INJECTION

## REINJECTION GUN

Aesthetic  
Group

### PISTOLETS DE RÉINJECTION DE GRAISSE AUTOCLAVABLE FAT REINJECTION GUN

REF. Volume (ml)

RU 0 1 0 1	1ml
RU 0 1 3 0	3
RU 0 1 2 0	20
RU051060	5/10/60



RU0130



RU0120



RU0101



RU051060

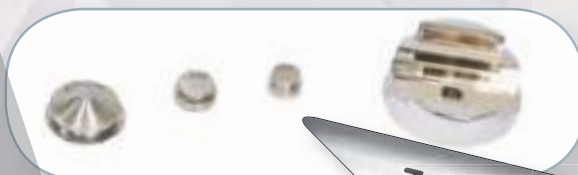

3 EN 1/3 IN 1

Couleur / Color :

Noir / Black

Blanc / White

Composition :

Uréthane élastique  
Stretch Nylon and  
urethane elastic fiber

### PANTY LONG ET ABDOMINAL GIRDLE WITH ABDOMINAL EXTENSION

REF : 01DY849



Description	1	2	3	4	5	6	7	8
Long. taille Width Waist	71	74	77	80	83	106	107	130
Long. pantalon Trousers length	73	76	79	82	85	85	85	85
Lon. jambe Leg length	38	41	44	47	50	50	50	50



Tailles / Sizes :

1, 2, 3, 4, 5, 6, 7, 8

Couleur / Color :

Noir / Black

Blanc / White

Composition :

Uréthane élastique  
Stretch Nylon and  
urethane elastic fiber

### PANTY LONG ET ABDOMINAL CHEVILLES GIRDLE WITH ABDOMINAL EXTENSION ANKLE LENGTH

REF : 05DY863

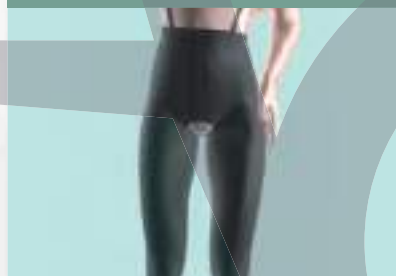

Description	1	2	3	4	5	6	7	8
Long. taille Width Waist	78	82	86	90	94	106	117	130
Long. pantalon Trousers length	93	96	99	102	105	105	105	105
Lon. jambe Leg length	66	69	72	75	78	78	78	78



Tailles / Sizes :

1, 2, 3, 4, 5, 6, 7, 8

Couleur / Color :

Noir / Black

Blanc / White

Composition :

Uréthane élastique  
Stretch Nylon and  
urethane elastic fiber

### PANTY COURT ET ABDOMINAL GIRDLE WITH ABDOMINAL EXTENSION ABOVE THE KNEE

REF : 02DY852



Description	1	2	3	4	5	6	7	8
Long. taille Width Waist	74	79	84	89	94	106	117	130
Long. pantalon Trousers length	52	57	62	66	70	70	70	70
Lon. jambe Leg length	24	28	30	32	34	34	34	34



Tailles / Sizes :

S, M, L, XL, XXL

Couleur / Color :

Noir / Black

Blanc / White

Composition :

Uréthane élastique  
Stretch Nylon and  
urethane elastic fiber

### GAINE ABDOMINALE AVEC BRETelles ABDOMINAL SUPPORTER WITH STRAPS

REF : 19DY865



Description	S	M	L	XL	XXL
Largeur taille Width waith	69	73	77	81	85
Longueur totale Overall length	37	37	37	37	37



### BODY CLASSIQUE FEMME

CLASSIC BODYSHAPER WOMAN

REF : 10DY850

Tailles / Sizes :  
S, M, L, XL, XXL

Couleur / Color :

Noir / Black

Blanc / White

Composition :

Uréthane élastique

Stretch Nylon and urethane elastic fiber



Description	S	M	L	XL	XXL
Largeur taille Width waith	68	72	76	80	84
Larg.poitrine Chest width	78	82	86	90	94

x1

### BODY HOMME

MALE BODYSHAPER

REF : 13DY850

Tailles / Sizes :  
S, M, L, XL, XXL

Couleur / Color :

Noir / Black

Blanc / White

Composition :

Uréthane élastique

Stretch Nylon and urethane elastic fiber



Description	S	M	L	XL	XXL
Larg. taille Width waith	81	85	89	93	97
Larg.torse Chest width	85	89	93	97	101
Long. totale Overall length	72	74	76	78	80

x1

### MANCHON

SLEEVE

REF : 37DY801B

Tailles / Sizes :  
S, M, L, XL, XXL

Couleur / Color :

Noir / Black

Blanc / White

Composition :

Nylon et uréthane élastique

Stretch Nylon and urethane elastic fiber



Description	S	M	L	XL	XXL
Longueur Length	18	19	20	21	22
largeur width	25	28	31	34	37

x2

### MASQUE RENFORCÉ POUR LIFTING

REINFORCED CHIN-NECK BANDAGE

REF : 35DY840

Tailles / Sizes :  
S, M, L, XL, XXL

Couleur / Color :

Noir / Black

Blanc / White

Composition :

Nylon et uréthane élastique

Stretch Nylon and urethane elastic fiber



Description	S	M	L	XL	XXL
Circonférence transversale Transverse circumference	44	47	50	53	56
Circonférence transversale Transverse circumference	61	64	67	70	73

x1

### SOUTIEN GORGE POST OPÉATOIRE POST OP BRA

REF : 3291

Tailles / Sizes :  
S, M, L, XL, XXL

Couleur / Color :  
Noir / Black

Blanc / White

Composition :  
Polyamide, élasthane  
Polyamide, elasthane

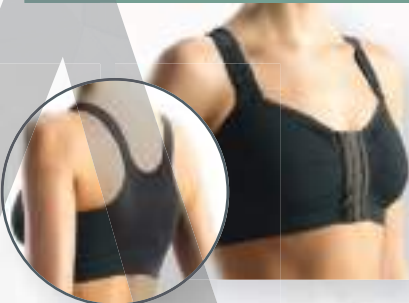

Band (cm)	70	75	80	85	90	95	100	105	110	115	120	
Size (inch)	28	30	32	34	36	38	40	42	44	46	48	
Cup size												
A												
B												
C												
D												
DD												
F												
G												
H												
	S	M	L	XL	XXL							



### STABILISATEUR D'IMPLANTS IMPLANTS STABILIZER BAND

REF : 8113

Taille unique / One size

Couleur / Color :

Noir / Black

Blanc / White

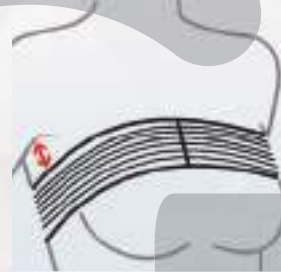
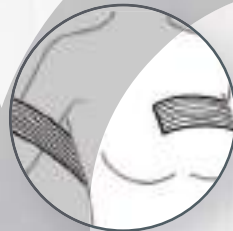

### BANDAGE ABDOMINAL - HAUT ABDOMINAL BINDER HIGH

REF : 3208

Composition :  
Polyamide, élasthane  
Polyamide, elasthane



Description	S	M	L	XL	XXL
Longueur de taille	78	86	94	102	112
Width Waist	90	98	106	116	130
Longueur totale Overall length	28,0	29,5	32,5	35,5	41,5



### BISTOURI STÉRILE EN ACIER INOXYDABLE STERILE SCALPEL IN STAINLESS STEEL



REF. U10 U10A U11 U15 U20 U21 U23 U24

Prix  
Price

7,20€



REF.

### LAME DE BISTOURI STÉRILE STERILE SCALPEL BLADE

Manche / Handle  
Réutilisable / Reusable



REF.  
M31G

Prix  
Price  
6,00€



### LAME FINE BISTOURI STÉRILE FINE STERILE SCALPEL BLADE



x25

REF.	SM61	SM62	SM64	SM65	SM65A	SM67	SM69	SP90	SP91
Prix Price			72,00€				127,20€	151,20€	

Manche pour lame "fine" / "Fine" handle  
Réutilisable / Reusable

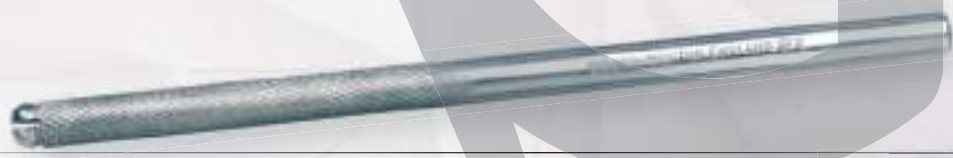

x1 REF.  
MFINE2

EXTRACTEUR DE LAME  
BLADE REMOVER



x50 REF.  
EXTST

EXTRACTEUR DE LAME AUTOCLAVABLE  
AUTOCLAVABLE BLADE REMOVER



x1 RB



REF.

**CENTRIFUGEUSE 10ml**  
10ml CENTRIFUGE

Fermeture sécurisée  
Détection automatique de déséquilibre / Ultra compact et légère **4kg**  
Digitale / Mise en pratique facile et rapide

CES10



*Lock safety  
Automatic imbalance detection / Compact and light weight  
Digital / New intuitive interface for a quick start*

La Centrifugeuse essentielle pour le traitement du sang dans les Cliniques / Hôpitaux et autres laboratoires de Diagnostic et de Recherche.

*The essential Centrifuge for Blood Processing in Clinics/ Hospital & other Diagnostic & Research labs.*

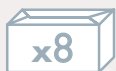

Support tube autoclavable  
(peut être vendu séparément)  
*Autoclavable holder  
(can be sold separately)*

REF.

MISC



**UNITÉ DE PRÉLÈVEMENT BD**  
BD VACUTAINER SAFETY LOCK



REF.

368654



**CORPS DE PRÉLÈVEMENT  
PRÉ-MONTÉ AVEC LUER FEMELLE BD®**  
BD® VACUTAINER BLOOD TRANSFER  
DEVICE WITH FEMELLE CONNECTOR



REF.

364810



# PLASMA RICHE EN PLAQUETTE

PLATELET-RICH PLASMA



PLASMA RICHE EN PLAQUETTE  
PLATELET-RICH PLASMA

P.R.P.



Exclusive



Pure PRP & Stem Cells Therapy  
for maximal results

		REF.
	1 tube <b>sous vide</b> pour la séparation du PRP avec gel de séparation & anticoagulant, pour collecter 10 ml de sang.	1 <b>vacuum tube</b> for PRP separation with gel & MACD7 (anticoagulant), for collecting 10 ml peripheral blood.
		PPT-1 
	1 tube <b>sous vide</b> pour la séparation du PRP - 10 ml. + 1 tube filtrant.	1 <b>vacuum tube</b> - 10 ml. + 1 sleeve filter.
		PPT-2 
	1 tube <b>sous vide</b> pour la séparation du PRP avec gel de séparation & anticoagulant, pour collecter 22 ml de sang.	1 <b>vacuum tube</b> for PRP separation with gel & MACD7 (anticoagulant), for collecting 22 ml peripheral blood.
		PRP22 
	1 tube <b>sous vide</b> pour la séparation du PRP - 10 ml 1 tube filtrant 1 aiguille 18G x 100 ml 1 seringue 10 ml 1 système de prélèvement sanguin 1 seringue luer lock 1 ml 1 aiguille hypodermique 30G	1 <b>vacuum tube</b> - 10 ml 1 sleeve filter 1 blunt needle 18 x 100 mm 1 10 ml syringe (to be used with the blunt needle) 1 VACU10 PSV set 1 1 ml luer lock syringe 1 hypodermic needle 30G
		PPK-1 
		1 x tube balance - 10 ml
		BT-10 

TUBE BALANCE PRP  
BALANCE TUBE PRP

L'injection de concentrés de plaquettes autologues à des fins esthétiques est interdite en France selon l'arrêt du Conseil d'Etat en date du 4 novembre 2015.



<b>PUNCH A BIOPSIE &amp; CURETTE / BIOPSY PUNCH &amp; CURETTE</b>	46
<b>PUNCH / CURETTE &amp; LAME BIOPSIE KAI / PUNCH / CURETTE &amp; BIOPSY BLADE KAI</b>	47
<b>CURETTE DERMATOLOGIQUE / DERMATOLOGICAL CURETTE</b>	48
<b>AURATIO® / NANO NEEDLE STAMP 0.5 &amp; 1.0mm (NANONEEDLING)</b>	49
<b>ROLLER DERMIQUE / SKIN ROLLER</b>	50
<b>LAMPE FRONTALE &amp; LOUPE / HEAD LIGHT NSE</b>	51
<b>PROTECTION LED - LASER - IPL / LASER - IPL - UV SAFETY</b>	52
<b>CRAYONS DERMOGRAPHIQUE / SKIN MARKER</b>	53





# DERMA



# PUNCH A BIOPSIE & CURETTE

b;ops

## BIOPSY PUNCH & CURETTE



### PUNCH À BIOPSIE BIOPSY PUNCH

Instrument stérile en acier inoxydable à usage unique pour des biopsies cutanées précises et douces.

Composés d'une lame circulaire en acier inoxydable et une poignée légère ergonomique.

Large gamme de diamètres disponibles.

Sterile single-use stainless steel instrument

*Sterile single-use stainless steel instrument for accurate and gentle skin biopsies.*

*Consisting of a circular stainless-steel blade and an ergonomic lightweight handle.*

*Wide range of diameters available.*



REF. Ø (mm)

PB150 1,5

PB200 2,0

PB300 3,0

PB400 4,0

PB500 5,0

PB600 6,0

PB800 8,0

Longueur / Length :  
87 mm



### CURETTE DERMATOLOGIQUE DERMAL CURETTE

Instrument stérile à usage unique pour le curetage précis et doux

La curette est extrêmement acérée et permet ainsi une élimination précise et douce des tissus, ce qui facilite également son utilisation dans le traitement des tumeurs malignes superficielles.

Composées d'une lame circulaire en acier inoxydable et d'une poignée légère de forme triangulaire pour une meilleure prise en main.

*Sterile disposable instrument for precise and gentle curettage*

*The curette is extremely sharp and allows a precise and gentle removal of tissue, which also facilitates its use in the treatment of superficial malignancies.*

*Consisting of a circular blade made of stainless steel and a light triangular handle for a better grip.*



CD2 2,0

CD3 3,0

CD4 4,0

CD5 5,0

CD7 7,0

Longueur / Length :  
145 mm

# PUNCH / CURETTE & LAME BIOPSIE KAI



## PUNCH / CURETTE & BIOPSY BLADE KAI



### PUNCH À BIOPSIE KAI BIOPSY PUNCH KAI

Bordure en acier inoxydable sans soudure.  
Manche polypropylène.  
Sans latex

*Seamless stainless steel half-edge.  
Polypropylene handle.  
Latex free*

REF.	Ø (mm)
48101	1,0
48115	1,5
48201	2,0
48301	3,0
48401	4,0
48501	5,0
48601	6,0
48801	8,0



### CURETTE DERMATOLOGIQUE KAI DERMATOLOGICAL CURETTE KAI

Lame anneau en acier inoxydable sans soudure.  
Manche polypropylène.

*Seamless stainless-steel ring blade.  
Polypropylene handle.*

50102	2,0
50103	3,0
50104	4,0
50105	5,0
50107	7,0



### LAME BIOPSIE KAI BIOPSY BLADE KAI

Lame en acier inoxydable sans soudure.  
Manche polypropylène.  
Longueur unique totale de 7cm.

*Seamless stainless-steel blade.  
Polypropylene handle.  
Total unique length of 7cm.*

REF.

51100



# CURETTE DERMATOLOGIQUE

## DERMATOLOGICAL CURETTE

Aesthetic  
Group



### CURETTE AVEC LAME INOX + GRATTOIR CURETTE WITH STEEL BLADE + SCRAPER

REF. Ø (mm) lame  
Inox/Steel Blade

CGL04 4 mm

CGL07 7 mm

Pour la déterction d'une plaie.  
For wound cleansing phase.



### CURETTE PLASTIQUE DOUBLE DOUBLE ENDED DERMAL CURETTE

REF.

D C 0 1

Longueur / Length : 135 mm



### CURETTE PLASTIQUE + GRATTOIR DERMAL CURETTE + SCRAPER

REF.

C G 0 2

Longueur / Length : 135 mm



### TIRE COMÉDON COMEDONE EXTRACTOR

REF.

T C 0 3

Ø3mm

Longueur / Length : 135 mm

Ø1,5mm

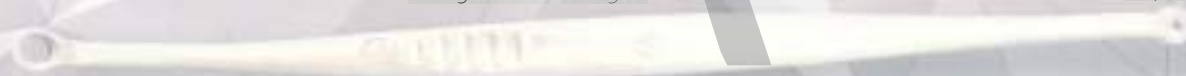

# NANO NEEDLE STAMP - Auratio®

Aesthetic  
Group

NANO MICRONEEDLING STAMP



## SYSTEME TAMPON NANO AIGUILLE + FIOLE 5ml NANO NEEDLE STAMP + VIAL 5ml

REF.

Aiguille de 0.5mm AUS05  
Needle of 1.0mm AUS10

Système complet de micro needling.

Applicateur de sérum au toucher fin.

Contenu :

- Fiole de verre de 5ml à remplir de sérum selon l'application souhaitée
- tête vissable avec 20 nano aiguilles en Titane plaqué Or :  $\varnothing$  0.13mm x0.5 ou 1.0mm
- Bouchon de protection

Complete system of micro needling.

Serum applicateur Fine Touch

Component :

- 5ml glass vial/tank to be filled with serum to the desired application
- screw head with 20 nano Gold plated Titanium needles :  $\varnothing$  0.13mm x0.5 or 1mm
- Protection cap

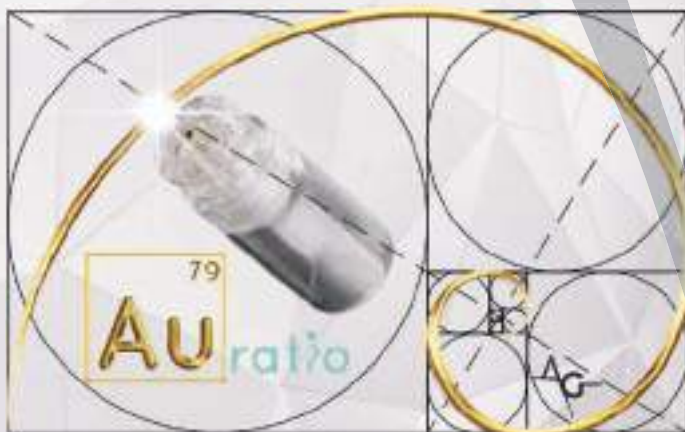

Usage Unique

Stérile à l'Oxyde d'Éthylène (ETO)

Ceci n'est pas un dispositif médical

Single Use

Sterile with Ethylene Oxide (ETO)

This is not a medical device



## ROLLER & STAMP

CEUX-CI NE SONT PAS DES DISPOSITIFS MÉDICAUX  
Those are not medical devices

### SKIN ROLLER "BASIC" - 192 AIGUILLES 192 NEEDLES

ROULEAU DERMIQUE  
192 aiguilles. stérile (OE).  
192 needles. Cosmetic use. Sterile skin roller.



REF.	Longueur Length (mm)
80205	0,5
80210	1,0
80215	1,5
80220	2,0



### SKIN ROLLER - 540 AIGUILLES 540 NEEDLES

ROULEAU DERMIQUE  
540 aiguilles. Stérile (OE).  
540 needles. Cosmetic use. Sterile (EO).



54005	0,5
54010	1,0
54015	1,5
54020	2,0



### EYE ROLLER - 180 AIGUILLES 180 NEEDLES

ROULEAU DERMIQUE  
180 aiguilles. Stérile (OE).  
180 needles. Cosmetic use. Sterile (EO).



E 0 0 3	0,3
E 0 0 5	0,5



# LAMPE FRONTALE & LOUPE

## HEAD LIGHT



EL-Q40



EL-P45



EL-S50100



EL-S50100B



EX-S30

x1

TYPE	Ø SPOT	ILLUMINATION	REF.
PROFESSIONAL	65-400mm	18 500 LUX	EL-Q40
EXPERT	88-450mm	40 000 LUX	EL-P45
SURGICAL	100-500mm	50 000 LUX	EL-S50100
+ LOUPE x3 (Grossissement/Magnification)	100-500mm	50 000 LUX	EL-S50100B
			EX-S30

EXTRA BATTERY : 3 Models = EL-Q40/ EL-P45 / EL-S50100(B) & EX-S30  
EXTRA LOUPES : EL-S50100B

Délai de livraison : 2 semaines - Delivery time: 2 weeks

REF.

23-442B

DURETTE PLASTIQUE PROTECTEURS EXTERNES  
EXTERNAL SHIELDS



Avec attaches nasales et temporales mobiles en plastique.  
*With movable plastic nasal and temporal attachments.*

Panneaux LED - optimisés à bandes spectrales étroites.

OD +5 190-2575 nm  
OD +4 2576-3000 nm

DURETTE IV EXTERNES  
DURETTE IV EXTERNALS



Avec attaches nasales et temporales mobiles en métal.

*With new swivel metal attachments.*

Régulier / Regular 21-555

Petit / Small 21-552

Pièces temporales  
Temporal parts 21-550T

Pièces nasales  
Nasal parts 21-550N

Elastiques de rechange noirs  
avec barrure.  
Spare black elastic  
headbands with cordlock. 21-536

Elastiques de rechanges  
blancs avec barrure.  
Spare white elastic  
headbands with cordlock. 21-537



COX® II PROTECTEUR OCULAIRE AUTOCLAVABLE  
COX® II OCULAR PROTECTOR AUTOCLAVABLE

Pour assurer la protection du globe oculaire et du personnel traitant. Leur surface non réfléchissante permet la dispersion du rayon laser et autres sources d'énergie.

*For protection of the patient and personnel. Their non-reflective surfaces disperse laser light.*

En trois tailles / 3 sizes

Une ventouse est fournie avec chaque protecteur pour en faciliter l'insertion et le retrait.

*A red rubber is offer with each protector, to make easier insertion and removal.*

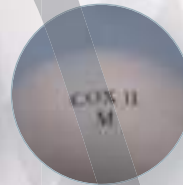

REF.

23-012



Ventouse  
Red Rubber



### COX II H AVEC POIGNÉE DÉCENTRÉE COX II H WITH HANDLE

Le Cox II H est vaulté à la cornée, identifié pour la grandeur et possède un anneau de sécurité à l'extrémité.  
The Cox II H is vaulted at the corneo, is marked for the size and has a safety ring at the edge.



	REF.
Gauche / Left - Petit / Small (24 x 21 mm)	21-262HL
Gauche / Left - Moyen / Medium (25,5 x 22 mm)	21-264HL
Gauche / Left - Grand / Large (26,5 x 23 mm)	21-266HL
Droite / Right - Petit / Small (24 x 21 mm)	21-262HR
Droite / Right - Moyen / Medium (25,5 x 22 mm)	21-264HR
Droite / Right - Grand / Large (26,5 x 23 mm)	21-266HR



### PROTECTEURS ET INSTRUMENTS EN INOX POUR UNE UTILISATION EN TOUTE SÉCURITÉ

STAINLESS STEEL QUALITY PRODUCTS FOR SAFE USE



Sutcliffe plié Sutcliffe bent	21-276
Sutcliffe plat Sutcliffe flat	21-275
Protection tout-en-un - All-in-one shield Pour taches de rousseur et lésions, idéal pour délimiter la région traitée. Lesions and freckle shield. To limit the size of the laser beam.	21-287

Avec surface non réfléchissante pour protéger du laser.  
Pour rétracter les tissus, pour cacher les cheveux, sourcils, cils, lèvres, dents, lobes, tissus, etc...  
With nonreflective surface to protect from the laser.  
You can shield eyelashes, eyebrows, eyelids, freckles, lips, gums, teeth, etc... and any tissue (deep or superficial) needing protection.



### PLAQUES PAUPIÈRES POUR PROCÉDURES AU LASER LID PLATE FOR LASER PROCEDURES



Khan-Jaeger Modèle standard plus plat, avec intérieur poli. The flatter standard shape, with the inside polished.	21-292
Jaeger Modèle standard plus plat, avec intérieur poli. The flatter standard shape, with the inside polished.	21-295

Un design ergonomique et plus incurvé, pour réduire la pression sur le globe - Le préféré.  
A more concave ergonomic design, helps avoid pressing on the globe, with the inside polished - The best.



### PLATEAU DE STÉRILISATION EN PLASTIQUE AUTOCLAVABLE AVEC COUVERCLE ET TAPIS AUTOCLAVABLE PLASTIC STERILIZING TRAY WITH LID AND MAT

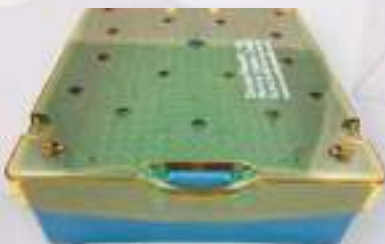

(6,5 x 3,0) (165 x 80 mm) (Hauteur 40 mm / Height 1.5) Petit / Small	27-6530
(6,5 x 4,5) (165 x 115 mm) (Hauteur 40 mm / Height 1.5) Grand / Big	27-6545



PROTECTION LED / UV

REF.

LED80606



x30



PROTECTION LASER - IPL  
500/1200NM

REF.

LAS36023



x45



PROTECTION PRATICIEN AUTOMATIQUE - SPÉCIAL IPL  
IPL SAFETY EYEWEAR LIGHT SPEED® III FOR OPERATOR

REF.

31-92900



x1



Les lunettes LightSpeed utilisent une technologie brevetée qui réagit instantanément au flash IPL en s'assombrissant en moins d'une demi-milliseconde (0,5 ms). Les lunettes Light Speed offrent une excellente vision à l'état clair, ce qui vous permet de voir les lésions pigmentées et vasculaires, tout en offrant une protection élevée pendant le flash IPL.

The LightSpeed eyewear uses patented technology that reacts instantly to the IPL flash, darkening in less than half a millisecond (0.5 ms). Light Speed eyewear offers excellent vision in the light state, allowing you to see pigmented and vascular lesions, while providing high protection during the IPL flash.

COQUES DE PROTECTION PATIENT LASER/IPL/UV  
LASER/ IPL/ UV SAFETY GOGGLES

REF.

617

METAL



x1

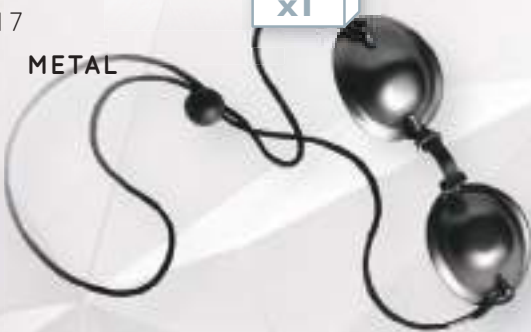

COQUES DE PROTECTION PATIENT LASER/IPL/UV  
LASER/ IPL/ UV SAFETY GOGGLES

REF.

616

ALUMINIUM  
"PLUS"



x1



### STYLO CHIRURGICAL STERILE SKIN MARKER FOR SURGERY

REF.	Trait Tip (mm)	Nb. Pcs Pcs
T3023	0,5 & 1,0	25



**Marqueur permanent spécial Visage & Corps avec 2 pointes :**  
fine de 0,5mm et large de 1,0mm de couleur violette.

*Permanent Skin Marker for Face & Body with 2 tips :*  
0.5mm thin and 1.0 mm wide in purple color.

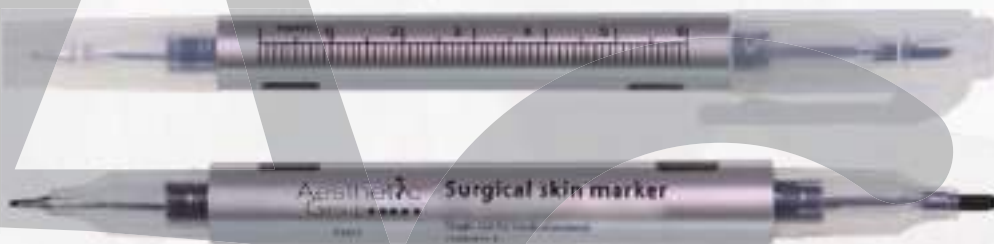

**Stérile (OE)**  
*Sterilized (OE)*

### STYLO FACILEMENT EFFAÇABLE EASILY REMOVABLE MARKER

**Description : Idéal pour  
les injections de toxine botulique et filler.  
Facilement effaçable.**

*Perfect for injection of botulinum toxin and filler.  
Easily removable.*

REF.

1 4 4 4
1 4 4 5
1 4 4 0

**Couleur  
Color**



**PISTOLET D'INJECTION "PRECISE" / MESO & INJECTION GUN "PRECISE"**

58

**CATHÉTERS / CATHETER**

60

**AIGUILLES / TUBULURES / NEEDLES / TUBING**

61

**"PIEUVRES" MESALYSE® / MESALYSE® "OCTOPUS"**

62



# inex MESO



# PISTOLET D'INJECTION "PRECISE"

MESO & INJECTION GUN "PRECISE"

precise

Next



## MÉSOThÉRAPIE

Synthèse de l'ensemble des techniques d'injections existantes, "Precise" est le résultat parfait de plus de 20 ans d'expérience dans le domaine des injecteurs médicaux. Condensé des plus hautes technologies au service de la médecine et de la beauté, "Precise" est la solution idéale et unique à l'ensemble de vos besoins quotidiens.

### 3 PROGRAMMES

**MESOTHERAPIE** : Pour des injections en rafale, nappage ou point par point, un réglage instantané de la profondeur et de la vitesse de l'aiguille vous permettront d'obtenir un geste sûr et précis pour une mésothérapie traditionnelle.

**EXPERT** : Programme spécialement dédié aux injections point par point, avec réglage de la profondeur (1 à 10 mm) et de la dose (0,01 ml à l'infini) pour optimiser l'efficacité des substances injectées en respectant scrupuleusement les protocoles.

**FILLERS** : Programme d'injection unique au monde destiné à la mise en place de fillers ou tout autre produit de comblement sur toutes les parties du corps. Réglage du volume injecté et de la vitesse de retrait de l'aiguille, contrôle de la profondeur. Idéal pour les rétro-injections tangentielles traçantes et parfaitement régulières.

## MESOTHERAPY

Synthesis of all the existing injection's techniques. "Precise" is the perfect result of more than 20 years of experience in the medical injector range.

By combining the highest technologies for serving medicine and beauty, "Precise" is the unique and ideal answer for your daily work.

### 3 PROGRAMS

**MESOTHERAPY**: For "nappage", point by point or continuous injections, the automatic control of depth and speed will allow you to get a traditional mesotherapy, safety and precisely.

**EXPERT**: Specific program dedicated to point by point injections, by the adjustment of the depth (from 1 to 13 mm) and the dose (from 0.01 ml to infinity), this program will optimize the efficiency of the products injected while strictly respecting the protocols.

**FILLERS**: Injection program unique in the world. "Precise" is programmed to set up filler or any other filling product on every part of the body. Possibility to adapt the volume of the product injected and the speed of the needle removing, while controlling the depth. Perfect for absolutely regular tangential retro-injections.

# PISTOLET D'INJECTION "PRECISE"

precise

MESO & INJECTION GUN "PRECISE"

Capteur pression seringue  
Syringe pressure sensor

Ecran de contrôle  
Control screen

Mire stabilisatrice & LED  
Stabilizing sight & LED

Connecteur pour recharge  
batterie  
Battery recharge connector

Bouton tactile  
Touch button

## CARACTÉRISTIQUES GÉNÉRALES

**AUTONOMIE TOTALE :** Fonctionne indifféremment sur batterie (Li-ion) ou sur secteur (90 V à 240 V).

**CONVIVAL :** Ecran graphique couleur de très haute définition, gestion tactile des commandes, mise en place d'un traitement en quelques secondes seulement.

**ERGONOMIQUE :** Design exceptionnel conférant au "Precise" un degré inégalé de maniabilité et de légèreté. Conçu spécialement pour une utilisation ambidextre.

**INDOLORE :** Vitesse de projection de l'aiguille supérieure à n'importe quel autre appareil, aucun phénomène vibratoire douloureux induit.

**LES PLUS :** Eclairage directionnel automatique de la partie du corps traitée pour une visibilité parfaite. Micro massage simultané ou post-injection pour une meilleure diffusion des produits. Plusieurs types de mires disponibles spécialement étudiées selon les programmes ou les parties traitées. Pas de kit exclusif, "Precise" accepte tout type d'aiguille ou de seringue. Détection automatique de la seringue et de la viscosité des produits injectés.

## GENERAL FEATURES

**SELF-CONTAINED:** Works equally on battery (Li-ion) or on mains (90 v to 240 V).

**USER-FRIENDLY:** Graphic colored screen VHD, sensitive management of controls, setting up of treatments in only few seconds.

**ERGONOMIC:** Exceptional design brings to "Precise" an unequalled level of handling and lightness. Especially designed for ambidextrous use.

**PAINLESS:** Speed of the needle's projection faster than any other unit. No pain effect induced.

**FURTHERMORE:** Directional lighting of the treated area for a perfect visibility. Simultaneous or post-injection massage for a better diffusion of the products. Several types of skin stabilizers available especially designed to be in accordance with the different programs or treated areas. No exclusive kit. "Precise" accepts all kind of needles and syringe. Automatic detection of the syringe and the viscosity of injected products.

Livré avec sa mallette de rangement et 2 cathéters réf. 10011

Delivered with its storage case and 2 catheters ref. 10011



REF.

PRECISE



### CATHÉTER PISTOLET TYPE MESO-SYSTEM

#### GUN CATHETER

Spécifiquement conçu pour l'utilisation du pistolet PRECISE  
15cm catheter.

*Developed for use with PRECISE GUN.*

REF.	Longueur Length (cm)
10 011	15



### CATHÉTER PISTOLET INEX COMPATIBLE TYPE M 1

#### INEX GUN CATHETER

Cathéter de 200cm.  
200cm catheter.

REF.	Aiguilles/Gauge Needle/Gauge	Longueur Length (cm)
10 012	0,26mm/32G	
10 013	0,30mm/30G	200
10 014	0,40mm/27G	



### CATHÉTER PISTOLET INEX COMPATIBLE TYPE M 3

#### INEX GUN CATHETER

Cathéter de 15cm.  
15cm catheter.

REF.	Aiguilles/Gauge Needle/Gauge	Longueur Length (cm)
10 312	0,26mm/32G	
10 313	0,30mm/30G	15
10 314	0,40mm/27G	



### CATHÉTER PISTOLET TYPE U225

#### INJECTION GUN CATHETER

Cathéter de 15cm.  
15cm catheter.

REF.	Aiguilles/Gauge Needle/Gauge	Longueur Length (cm)
10 112	0,26mm/32G	
10 113	0,30mm/30G	15
10 114	0,40mm/27G	





kipic™

### AIGUILLE POUR MÉSOTHÉRAPIE MESOTHERAPY NEEDLE



REF.	Ø (mm) Gauge	Longueur Length (mm)
KIPIC 33 G 0 8	0,21/33G	8
KIPIC 33 G 0 4	0,21/33G	4
KIPIC 32 G 0 8	0,23/32G	8
KIPIC 32 G 0 4	0,23/32G	4
KIPIC 30 G 0 4	0,30/30G	4
KIPIC 27 G 0 4	0,40/27G	4



### TUBULURE CARBOXYTHÉRAPIE CARBOXYTHERAPY TUBING

Mâle / femelle.  
Male / female.



REF.	Longueur Length (cm)
1826.P20	150

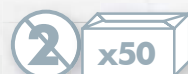

### TUBULURE TYPE RYOBLUSH RYOBLUSH TUBING

Mâle / femelle.  
Male / female.

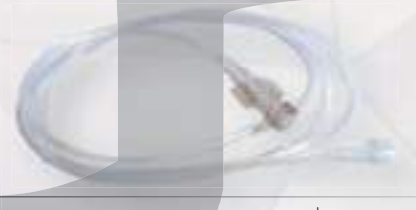

REF.	Longueur Length (cm)
1826.P30	150



### TUBULURE TYPE RYOBLUSH + FILTRE RYOBLUSH TUBING + FILTER

Mâle / femelle.  
Male / female.



REF.	Longueur Length (cm)
1826.P50	150



### FILTRE ANTIBACTÉRIEN ANTI BACTERIAL FILTER

0,2 µm  
Mâle / femelle.  
Male / female.



REF.
A0523

“PIEUVRES” MESALYSE®

MESALYSE® “OCTOPUS”

MESALYSE

NEW!

MESALYSE®

KIT MÉSOPERFUSION “PIEUVRE”

MESO-PERFUSION “OCTOPUS” CATHETER



REF.	Aiguilles Needles (x..)	Taille Aiguilles Needle Size
10040	0	4 connexions MLL 4 MLL Connectors
10085	8	
10125	12	
10185	18	0,5 x 16mm
10245	24	

New!

“PIEUVRES” MESALYSE®

MESALYSE

MESALYSE® “OCTOPUS”

MESALYSE®

Le KIT de mésoperfusion d'ORIGINE pour la technique d'hydrotomie percutanée  
*The ORIGINAL mesoperfusion KIT for the percutaneous hydrotomy technique*

MESALYSE® est le fabricant originel, unique et officiel des pieuvres utilisées pour la technique de soins par l'Hydrotomie percutanée développée par le Dr Bernard GUEZ depuis 1997.

*MESALYSE® is the original, unique and official manufacturer of “octopus” used for the percutaneous hydrotomy care technique developed by Dr. Bernard GUEZ since 1997.*

MESALYSE® est le fournisseur officiel de :  
*Official supplier of*



**SOCIÉTÉ INTERNATIONALE  
D'HYDROTOMIE PERCUTANÉE  
(A.I.H.P.)**



**Hydrotomie Percutanée  
Nice Côte d'Azur**





# BEAUTY







Ce masque tissu est imprégné d'un sérum riche en acide hyaluronique, en agent liftant (Osilift®) et en cellules souches de pomme afin de soutenir la capacité de régénération naturelle de la peau et agir favorablement sur le renforcement de la barrière de protection.

La peau conserve ainsi sa jeunesse plus longtemps, son aspect est amélioré et elle paraît plus fraîche.

*This tissue mask is impregnated with a rich serum in hyaluronic acid, lifting agent (Osilift®) & apple stem cells in order to support the natural regeneration capacity of the skin and to act favorably on enhancing the protective barrier.*

*Fine lines and wrinkles are reduced, while hydration, firmness and elasticity are reinforced.*

### INGRÉDIENTS :

- PhytoCellTec™
- Acide Hyaluronique
- Osilift®



Bio Cell Mask



REF.

MBIOHA

NEW



Le masque bio-cellulosique apporte éclat et souplesse. Lors de l'application, cette seconde peau forme une membrane protectrice qui véhicule uniformément et efficacement les ingrédients dont elle est imprégnée. Ce masque hydrate et adoucit la peau.

*Bio cellulose mask soothes and hydrates the skin, giving it a radiant & supple appearance after just 20 minutes of use. When applied, it forms a protective membrane that carries efficiently the beneficial ingredients contained in powerful serums. This bio-cellulose mask deeply hydrates and softens the skin.*

### INGRÉDIENTS :

- Aloe vera
- Hyaluronic acid
- Collagen
- Glycerin
- Fucogel®



HA Hydro-Mask



REF.

MHACAV



*Aesthetic*

*Surge*

*Derma*

*Meso*

*Beauty*

# OEM solution

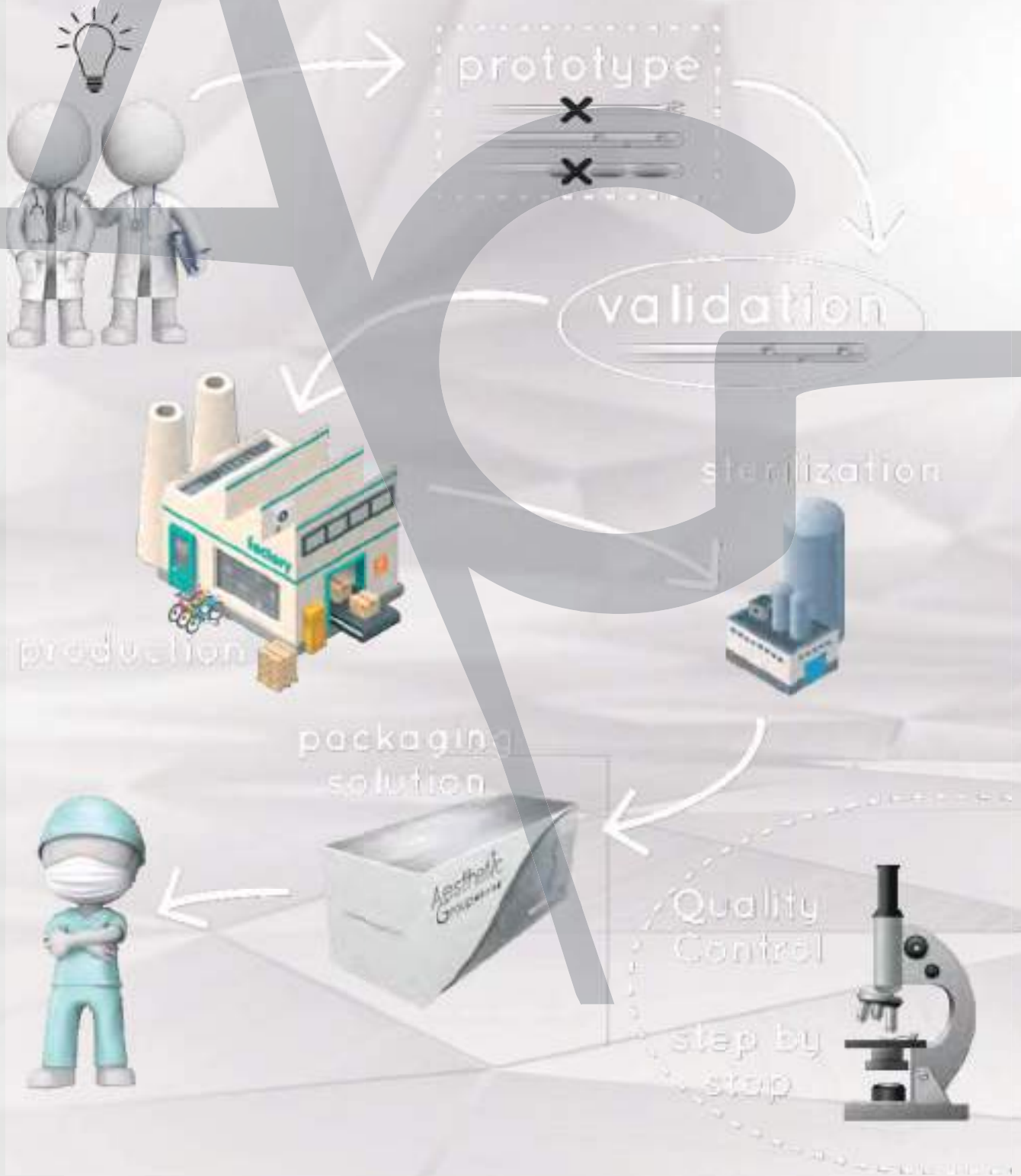

[info@aestheticgroup.fr](mailto:info@aestheticgroup.fr)